

# Molteni & C

## GLISS MASTER — VINCENT VAN DUYSSEN 2015

1—  
41



Molteni&C has extended the possibilities for Gliss Master, renewing the architectural concept of the nighttime area. The melamine offering is enriched with a new internal finish, a “White” texture, and a new warm Bronze finish, feminine and sophisticated, which represents the latest interpretation of this metal. The insides feature new accessories, such as the top of the structure which can be made of glass, to make the wardrobe even more transparent. The Master chest-of-drawers also has new tops, one made of transparent glass framed in Pewter and Bronze-coloured aluminium, which, thanks to the LED lighting, enhances the drawer inside; the other enriched with a stackable and pull-out threelayer trinket tray, which can be positioned at will. Two new options for the doors: “Swing” door, matt lacquered, which can be opened at 180°. “Twin” door, with the strong formal appeal typical of Vincent Van Duysen, with a new Pewter-coloured outer handle.

The Internet Of Things (IOT) joins the world of Molteni&C nighttime systems – Gliss Master and Master Dressing – with avant-garde solutions and innovations that guarantee wardrobes the best environmental quality. AIRCUB® – a Molteni&C exclusive – is an IOT device easily manageable from your smartphone with a dedicated APP. The air purification and perfuming system works by ionizing and ozonizing wardrobe interiors, thereby removing up to 95% of agents harmful to health, while releasing delicate fragrances.

### DATASHEET

REGISTERED  
DESIGN

IX.2018

[moltenigroup.com](http://moltenigroup.com)

Dimensions in millimeters and inches. The right to discontinue and make changes is reserved. This information is based on the latest product information available at the time of printing.

## FINISHES

### Finishes components

		melamine structure	melamine front	mat lacquer colours	cartapaglia lacquered	glossy lacquer colours	woods	coloured glass/etched coloured glass/mirror	shiny aluminium/black chrome	pewter colour/bronze	Eco Skin	extraclear transparent glass/transparent stopsol/stopol	fine grain
linear module and corner module	base/lid												
	back panel											only linear	
wooden central partition													
wooden external side panel													
extension profile													
central partition or side panel frame or glass	frame												
	glass											central only transparent	
START / TWIN door													
"A FILO" door													
"A FILO" glass door	profile												
	glass												
BLADE sliding door													
GRIP door													
DEEP door													
NICHE door													
GLASS door	profile												
	glass												
SWING door													
WINDOW door	profile												
	glass												
SKIN door	profile												
	panel												

		melamine structure	melamine structure pewter colour/bronze profile	Eco Skin pewter colour/bronze profile	fine grain pewter colour/bronze profile	transparent glass	pewter colour/bronze	grey saffiano melamine	larix dark/silver cembran	mat lacquer colours	
<b>internal fittings</b>											
shelf											
wooden drawer fronts H 126/190/382											
tray front (trouser holders/trinket trays)											
front for open drawers / pull-out trays											
glass drawer fronts/ glass shelf	profile										
	glass										
drawer internal											
dividing partitions - grid with shirt/sweater holders											
island drawer unit											
drawer unit											

### colours

#### Melamine structure

YB white shantung  
YG grey shantung  
YM larix dark  
YA silver cembran  
WW white

#### Melamine front

KA cartapaglia anthracite  
KB cartapaglia white  
KS cartapaglia silica  
WS graffiato bronze  
ZB silk chalk white  
ZS silk silica  
ZT silk dove grey

#### Matt lacquer/ Cartapaglia lacquered

BC chalk white  
PE pearl  
DN dune  
PL platinum  
NE black  
AT anthracite  
SE mustard  
SI silica  
DO dolomite grey  
AL clay  
MK moka  
CM caramel  
CZ light blue grey  
SA sand  
RU ruby  
RE rust  
PX pewter colour  
RX copper  
TO dove grey

#### Glossy lacquer

BC chalk white  
PE pearl  
DN dune  
PL platinum  
NE black  
AT anthracite  
SE mustard  
SI silica  
DO dolomite grey  
AL clay  
MK moka  
CM caramel  
CZ light blue grey  
SA sand  
RU ruby  
RE rust  
PX pewter colour  
RX copper  
TO dove grey

#### Coloured glass

BC chalk white  
PE pearl  
DN dune  
PL platinum  
NE black  
AT anthracite  
SE mustard  
SI silica  
DO dolomite grey  
AL clay  
MK moka  
CM caramel  
CZ light blue grey  
SA sand  
RU ruby  
RE rust  
PX pewter colour  
RX copper  
TO dove grey

#### Etched coloured glass

BC chalk white  
PE pearl  
DN dune  
PL platinum  
NE black  
AT anthracite  
SE mustard  
SI silica  
DO dolomite grey  
AL clay  
MK moka  
CM caramel  
CZ light blue grey  
SA sand  
RU ruby  
RE rust  
PX pewter colour  
RX copper  
TO dove grey

#### Woods

EU eucalyptus  
RG grey oak  
RF graphite oak

#### Eco Skin

grey  
mink  
hemp  
ivory  
dark brown

Molteni & C

### DATASHEET

REGISTERED  
DESIGN

IX.2018

## TECHNICAL INFORMATION

### STRUCTURE

#### BASE

Wooden particleboard panel faced with melamine and adjustable feet in contact with the ground.

#### COVER, PARTITION AND BACK PANEL

Wooden particleboard panel faced with melamine. The partitions are provided with adjustable feet in contact with the ground.

#### FINE GRAIN BACK PANEL

Chipboard coated with cylinder etched coextruded sheet of ABS-PMMA, painted in specific Molteni finish.

#### BACK PANEL, LID, SIDE PANEL AND CENTRAL PARTITION (GLASS)

Frame perimeter in painted extruded aluminium with 4 mm tempered glass. Available in different finishes.

#### SIDE PANEL (MELAMINE)

Wooden particleboard panel faced with melamine. Adjustable feet in contact with the ground.

#### SIDE PANEL (MATT OR GLOSSY LACQUERED IN THE COLOURS)

Wooden particleboard panel faced with melamine. Outside painted in the colours of the "Molteni Range". Adjustable feet in contact with the ground.

#### SIDE PANEL (WOOD)

Wooden particleboard panel with inner melamine facing and outer facing with sliced Oak (Quercus) or Eucalyptus (Eucalyptus globulus). Adjustable feet in contact with the ground.

#### CENTRAL FRAME PARTITION

Frame perimeter in painted extruded aluminium.

#### COVERING PROFILES AND RUNNERS

Extruded aluminium covered with melamine facing or painted, with dust-proof seals.

#### FRONT EDGING

Anodised extruded aluminium, lacquered in the "Molteni Range" colours or faced with sliced Oak or Eucalyptus.

### DOORS

#### MELAMINE (START - TWIN - "A FILO" - BLADE - GRIP - DEEP)

Wooden particleboard panel faced with melamine. Cushioned hinges and sliding system. Handles in various materials and finishes.

#### MATT OR GLOSSY LACQUERED IN THE COLOURS (START - "A FILO" - BLADE - GRIP - DEEP - NICHE - SWING)

Wooden particleboard panel faced with melamine, painted in the colours of the "Molteni Range". Cushioned hinges and sliding system. Handles in various materials and finishes. For the SWING model, the panel is trimmed using a painted aluminium extrusion.

#### WOOD (START - TWIN - "A FILO" - BLADE - GRIP - DEEP - NICHE)

Wooden particleboard panel faced with sliced Oak or Eucalyptus. Handles in various materials and finishes.

#### GLASS HINGED DOOR ("A FILO")

Wooden particleboard panel faced with melamine, with a 5-mm-thick glass panel or mirror applied, painted in the colours of the "Molteni Range". Outer frame profile of anodised extruded aluminium. Cushioned hinges.

#### GLASS SLIDING DOOR ("A FILO")

Frame in anodised extruded aluminium with mounted mirror or 5 mm glass, painted in "Molteni Range" colours. Sliding system with shock absorbers.

#### GLASS doors

Extruded aluminium frame with 4 mm glass available in different finishes. Recessed hinges with 180° opening.

#### WINDOW doors

Frame in painted extruded aluminium with 5 mm glass available in different finishes. Recessed soft close hinges.

#### SKIN doors

Frame in painted extruded aluminium with honeycomb panel inserted and covered in eco-leather. Recessed soft close hinges.

### DATASHEET

REGISTERED  
DESIGN

IX.2018

**TECHNICAL INFORMATION**

**INTERNAL FITTINGS**

**PULL-OUT SHIRT HOLDER**  
 Painted parts made using a phenolic laminated panel. Front tray made of woodchip board faced with melamine. Bottom clad in eco-leather

**DRAWER UNIT STRUCTURE FOR FRAME SIDES**  
 Chipboard panel with melamine facing, painted in specific Molteni finish.

**INNER SHELVES, DRAWER OR TRAY FRONT, MOVABLE TRAYS SET AND GRID WITH SHIRT AND SWEATER HOLDERS**  
 Wooden particleboard panel faced with melamine.

**INNER SHELVES WITH FRONT PROFILE**  
 Chipboard panel covered with melamine facing, front profile in painted extruded aluminium.

**INNER SHELVES IN ECO SKIN**  
 Chipboard panel covered with melamine facing, front profile in painted extruded aluminium and upper covering in eco-leather.

**CLOTHES RODS**  
 Anodised aluminium rod. Tube support of chrome-plated plastic material.

**GLASS FRONT PANEL AND GLASS SHELVES**  
 In painted or extruded aluminium. 4-mm-thick tempered glass.

**FINE GRAIN FRONT**  
 Chipboard panel covered with cylinder etched coextruded sheet of ABS-PMMA, painted in specific Molteni finish. Perimeter profile in painted extruded aluminium.

**DRAWER AND TRAY INNER SIDES**  
 Wooden particleboard panel faced with melamine.

**DRAWER AND TRAY INNER BOTTOM**  
 Wooden particleboard panel faced with melamine.

**SHOE RACK AND TROUSER RACK PROFILES**  
 In anodised or painted aluminium extrusion.

**PULL-OUT MIRROR**  
 Metal frame with mirror 4 mm th.

**HANDLES AND VARIOUS ACCESSORIES**  
 In various materials and finishes.

**BASE, TOP AND SHELVES IN WOOD (ISLAND WITH GLASS DOORS)**  
 Chipboard panel covered with wood veneer in Eucalyptus or Oak.

**IONISER**  
 See technical sheet enclosed with the product.

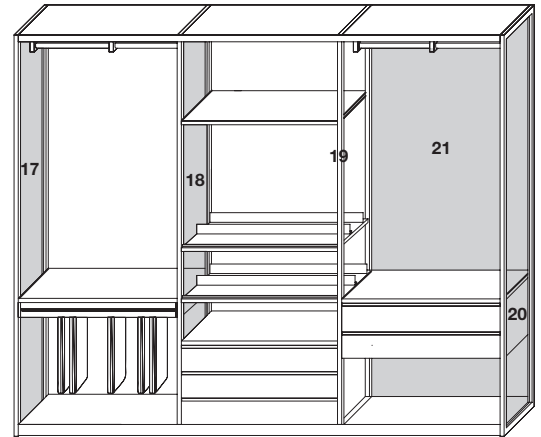
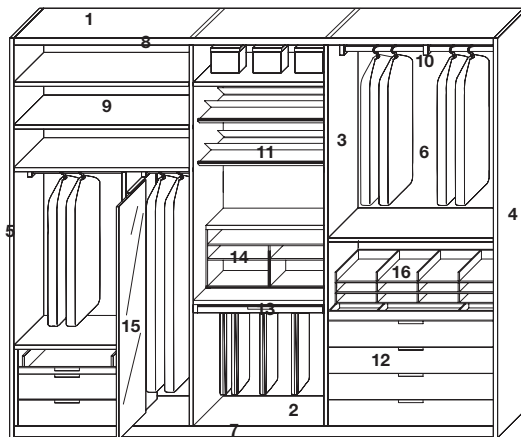

- 1 Top
- 2 Base
- 3 Partition
- 4 Side
- 5 Extension profile
- 6 Back
- 7 Covering profile or bottom runner
- 8 Covering profile or top runner
- 9 Shelf th. 30
- 10 Clothes rails
- 11 Shoe rack shelf
- 12 Drawers
- 13 Trousler holder - trinket trays
- 14 Grid with shirt and sweater holders
- 15 Pull-out mirror
- 16 Pull-out shirt holder

- 17 Side glass panel
- 18 Central glass partition
- 19 Central frame partition
- 20 Drawer unit structure
- 21 Glass back panel

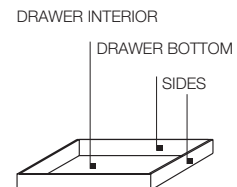

**DATASHEET**

REGISTERED  
 DESIGN

IX.2018

## MODULARITY

### Modularity - Structure

The widths 492 - 656 - 820 - 984 - 1312 - 464 (term. element) mm (19 3/8" - 25 7/8" - 32 1/4" - 38 3/4" - 51 5/8" - 18 1/4") include the left side panel. The total width of the composition will include the final panel of th. 30 mm (1 1/8").  
 Heights: tot. H 2343 (92 1/4"), door 2313 (91"), int.2253 (87 3/4"), sliding or flush sl. door inter. 2163 (85 1/8")  
 tot. H 2439 (96"), door 2409 (94 7/8"), int. 2349 (92 1/2"), sliding or flush sl. door inter. 2259 (88 7/8")  
 tot. H 2631 (103 5/8"), door 2601 (102 3/8"), int. 2541 (100"), sliding or flush sl. door inter. 2451 (96 1/2")  
 tot. H 2919 (114 7/8"), door 2889 (113 3/8"), interior 2829 (111 3/8"), only hinged

### Assembly instructions

For the assembling of a sliding and a flush sliding door wardrobe a minimum space of 6 cm (2 3/8") is required considering the minimum height of the compartment.  
 Assembly of the corner element (for wardrobe with doors) requires a minimum extra height of 6 cm (2 3/8").  
 Assembly of a wardrobe in an alcove requires a minimum extra side space of 4 cm (1 5/8").  
 A wardrobe with hinged doors and a lighting system requires a minimum extra height of 5 cm (2").

# Molteni&C

5—  
41

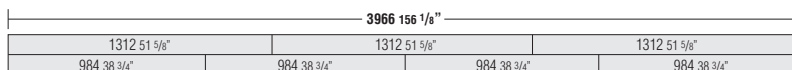
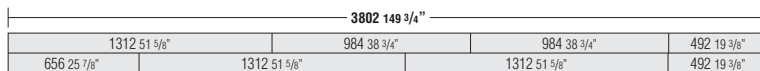
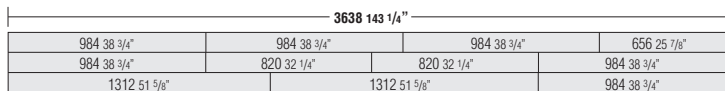
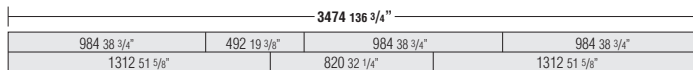
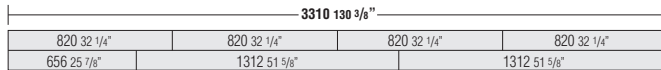
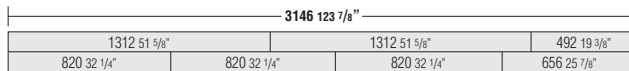
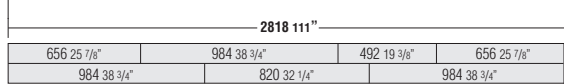
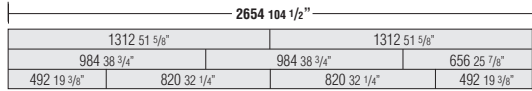
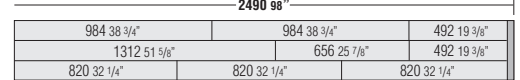
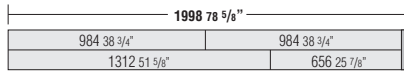
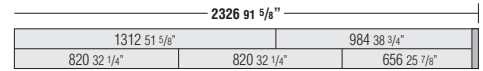
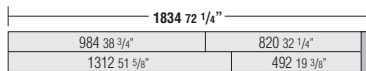
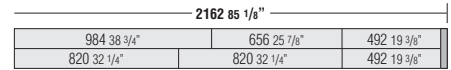
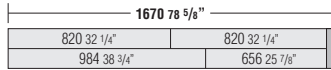
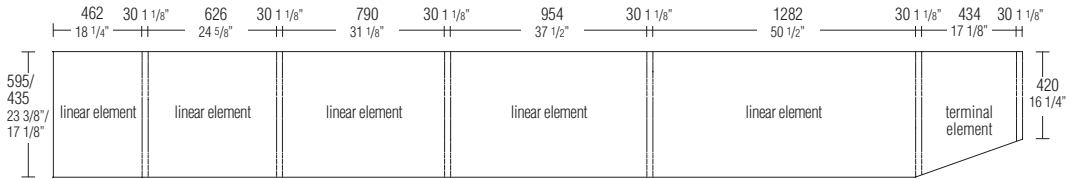

### DATASHEET

REGISTERED  
DESIGN

IX.2018

**DOORS**

**START-TWIN hinged doors**  
applicable only on structures  
with wood sides

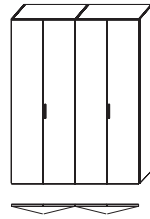

In the pairs of TWIN hinged doors W 815, 979 and 1307, are availables 2 handles or handle only on right door.

total height  
above floor  
1190 46 7/8"

The pairs of hinged doors START and "A FILO" always have a handle mounted on the right door.

**"A FILO" hinged doors**  
applicable only on structures  
with wood sides

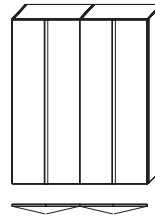

**DEEP-GRIP hinged doors**  
applicable only on structures  
with wood sides

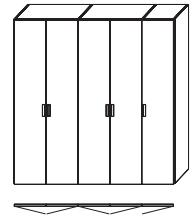

total height  
above floor  
1080 42 1/2"

**NICHE doors**  
applicable only on structures  
with wood sides

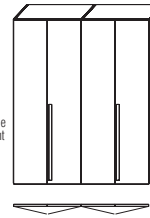

In the pairs of hinged doors W 815, 979 and 1307, are availables 2 handles or handle only on right door.

total height  
above floor  
950  
37 3/8"

handle  
height  
890  
35"

**WINDOW - SKIN door**  
applicable on all types  
of structures

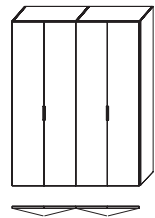

The hinged doors WINDOW and SKIN are made with recessed hinges fixed to base and top, and have a thickness of 30 mm

total height  
above floor  
1080 42 1/2"

**GLASS-SWING doors, th 35**  
applicable on all types  
of structures

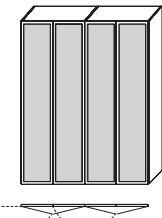

GLASS-SWING doors are made with 180° hinges built into the side (a Molteni exclusive)

180° 180°

**Sliding doors**

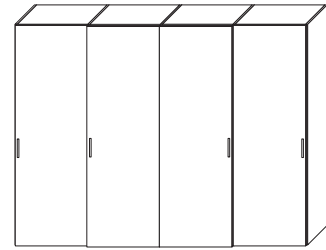
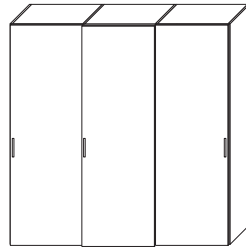

It is possible to make sliding door wardrobes with doors of the following types:

- START
- "A FILO"
- GRIP
- DEEP
- BLADE

It is possible to make the external sliding door with two handles if using the "A FILO" or BLADE door (full-height handle) and applying the surcharge

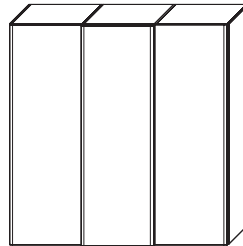

**Detail of side panel  
with extension profile**

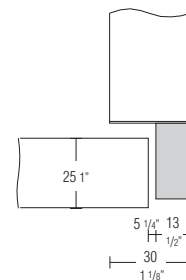

**with BLADE door**

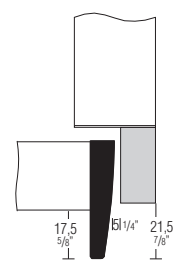

**Flush sliding doors**

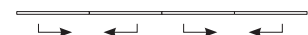
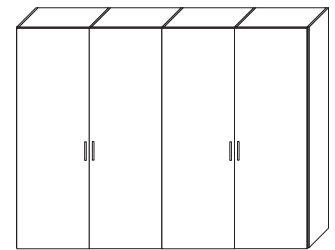
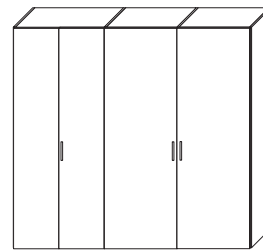
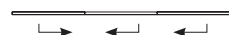
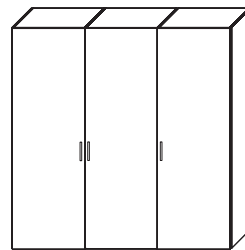
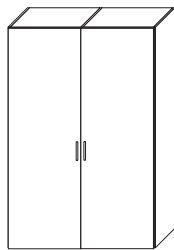

**DATASHEET**

REGISTERED  
DESIGN

IX.2018

## DOORS

### 155° opening (only for compartments with wooden sides)

On **START - TWIN - "A FILO" - GRIP - DEEP - NICHE** doors it is also possible to use **155° opening hinges, with an extra charge per individual door**. In this case, it is necessary to take special care in inserting internal drawer units, trinket trays and devices.

It is also necessary to comply with the diagrams provided here.

Molteni & C

7—  
 41

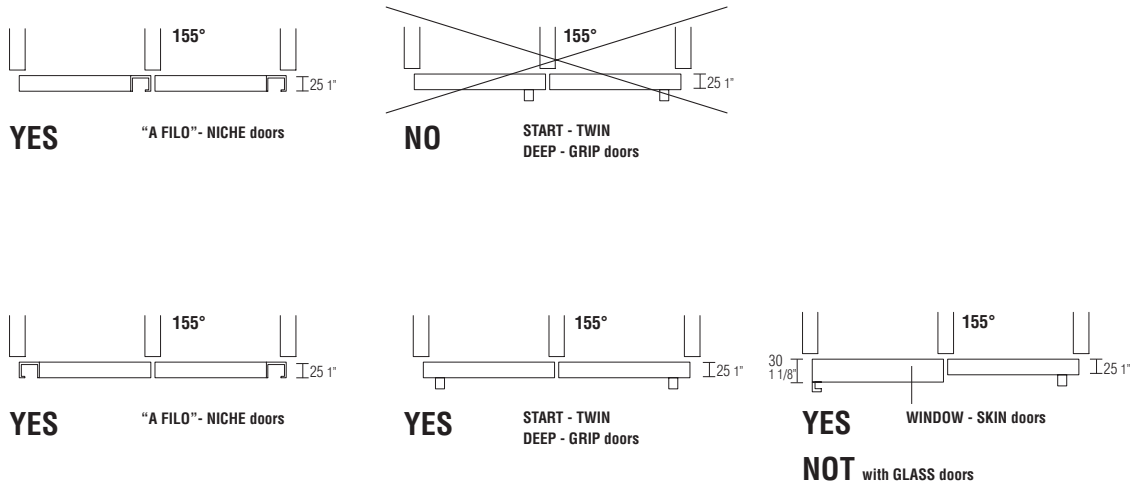

### Hinged doors with key lock

For the hinged doors specified, a key lock can be fitted to order. There is an additional cost for one or two doors. It can even be fitted on a terminal element or a corner element (in compliance with the handle installation rules). For doors with a lock, the internal drawer units must be suspended. Installation of only the lock can be requested, without a handle, always considering the price of the START doors and the additional cost of the lock.

START door handle type "M"

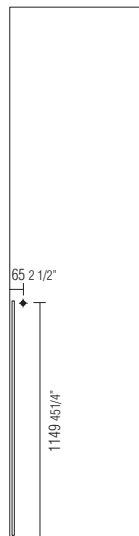

START door handle type "E"

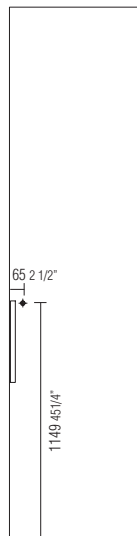

"A FILO" door

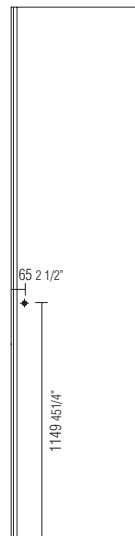

DATASHEET

REGISTERED  
 DESIGN

IX.2018

## CORNER ELEMENT

### Corner element D 595 - open or with GLASS/SWING doors

The corner element is provided complete with a base, lid and backs (melamine or fine grain). Between the corner element and the adjacent modules, it is necessary to insert central partitions in melamine, frame or glass.

The corner element can also receive a side panel to close the composition. Compartments adjacent to the closed corner element can be open or closed with GLASS or SWING doors.

#### Notes

The shelf is not included in the price of the corner element. Shelves and lids can be fitted with LED lighting bars, as indicated in the drawing below.

#### Reductions

The corner element can be reduced in height, width and depth. In width, the reduction can be carried out either on one side only or on both sides, up to a minimum width of 1101 mm.

Reduction in depth can be done on one or on two sides, up to a minimum of 435 mm. If only one side is reduced, that will be the side with the longest shelves (\*).

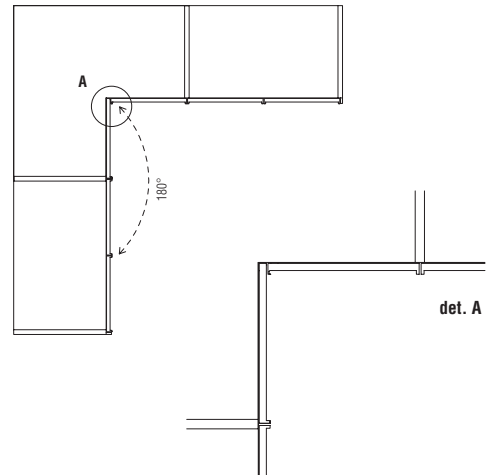
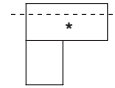

Molteni & C

8—  
 41

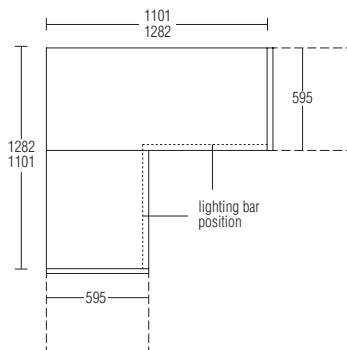
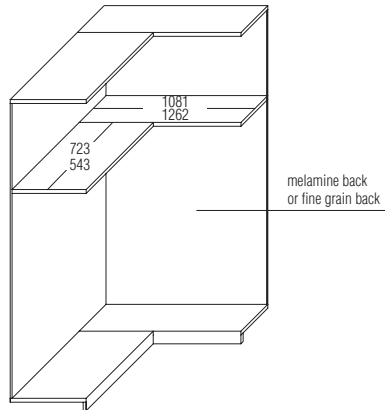

The corner element can be fitted with shelves and clothes rails, or with this solution of drawer units that have a central partition H 1158 where the desired drawer unit can be inserted. The drawer unit can be with fronts W 420 or 584.

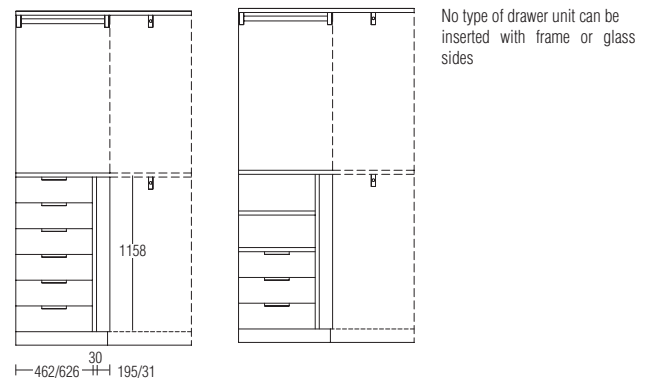
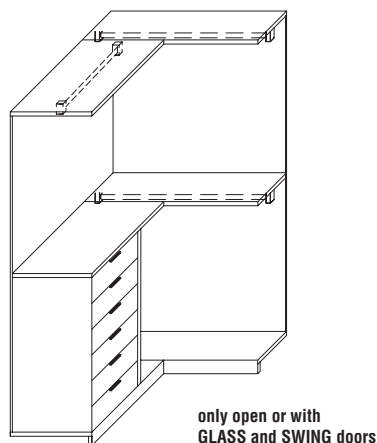

#### DATASHEET

REGISTERED  
 DESIGN

IX.2018

## STRUCTURE

### Structure for walk-in closet

In version **A**, the structure (base, lid, central partitions, back and side panels) is in melamine, in the same finish as the structure.

The back piece can also be provided in fine grain finish.

The side panels are always provided without extension profile (see detail).

In version **B**, the central partitions and sides are made with an aluminium frame with pewter colour or bronze finish, with or without glass.

Base, lid and back piece are in melamine, in the same finish as the structure.

The back piece can also be provided in fine grain or glass finish.

Horizontal tags on the base and lid are made in a pewter colour or bronze finish like the side frames.

In version **C**, given the presence of frame sides in pewter colour finish, the central and side partitions in melamine are also made with from tags in pewter colour or bronze, considering the specific price.

Molteni & C

9—  
 41

#### version A - Structure with wooden sides (melamine in the same colour as the structure)

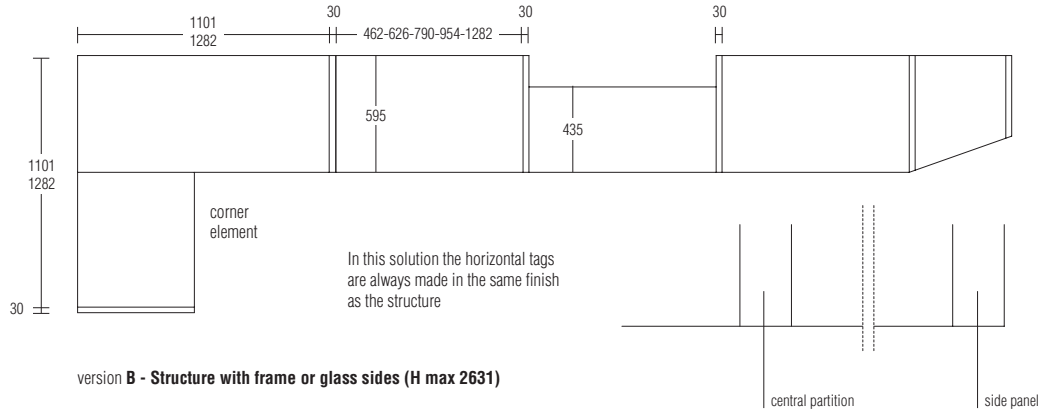

#### version B - Structure with frame or glass sides (H max 2631)

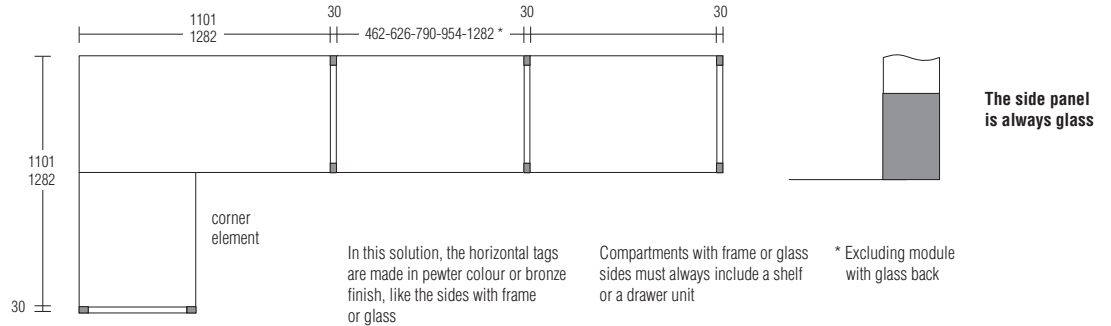

#### version C - Structure with mixed sides (H max 2631)

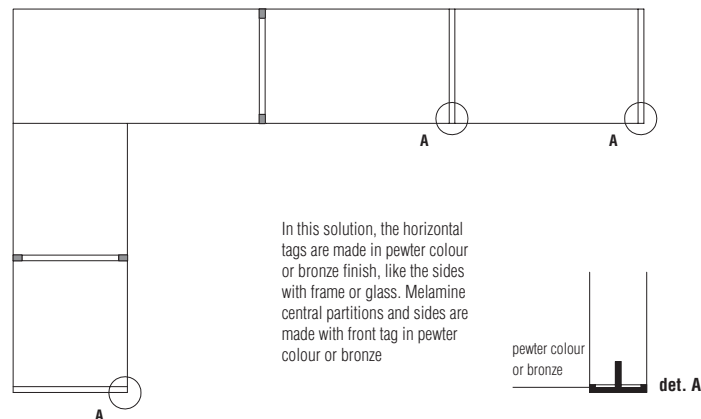

DATASHEET

REGISTERED  
 DESIGN

IX.2018

## STRUCTURE

### Linear modules

Linear modules are made up of a base and lid always made in melamine in the same finish as the structure.

The back is available in the three versions indicated below.

**A1** and **A2** can be reduced in height, width and depth if closed by sides and doors that are compatible with the requested reductions.

**A3** can be reduced only in height.

### Central partitions

These are available in melamine, in the same finishes as the structure, frame and glass.

The melamine version can be reduced in height and depth.

The frame and glass versions can be reduced only in height.

Compartments with frame or glass sides must always include a shelf or a drawer unit.

### Side panels

These are available in melamine, in the same finishes as the structure, frame and glass. The melamine version can be reduced in height and depth.

The outside of the side panel is available in the matt lacquer, glossy lacquer or wooden (vertical grain) finishes.

The standard finish on side panels is an extension profile in the coloured matt lacquer, pewter colour, bronze, shiny aluminium or black chrome finishes (to be specified in the Order). The extension profiles for glossy lacquer or wood side panels always match the side panels of the same finish.

The frame and glass versions can be reduced only in height.

Compartments with frame or glass sides must always include a shelf or a drawer unit.

Molteni & C

10—  
41

### A1 - Melamine back

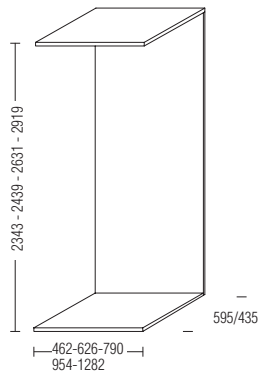

**A1**  
Base, lid and back made in melamine finish matching the structure

### A2 - Fine grain back

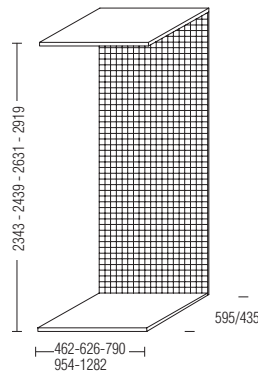

**A2**  
Base and lid made in melamine finish matching the structure. Back with fine grain finish

### A3 - Glass back

(only hinged GLASS, WINDOW and closet)

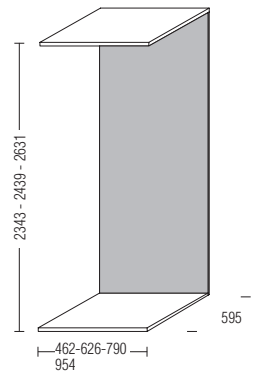

**A3**  
Base and lid made in melamine finish matching the structure. Back in glass, **only made with frame and glass sides.** It is possible to produce single finished modules W 790/954 with lateral pieces in glass by using the glass lids

### Central partitions, th 30

#### Warning:

frame sides and glass sides will only have holes at the position of the shelves. Complete hole series at regular intervals 96 mm will involve an extra charge per side.

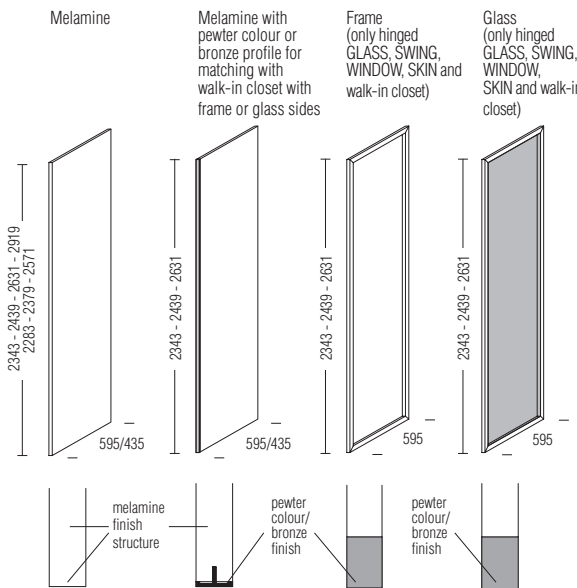

### Side panels, th 30

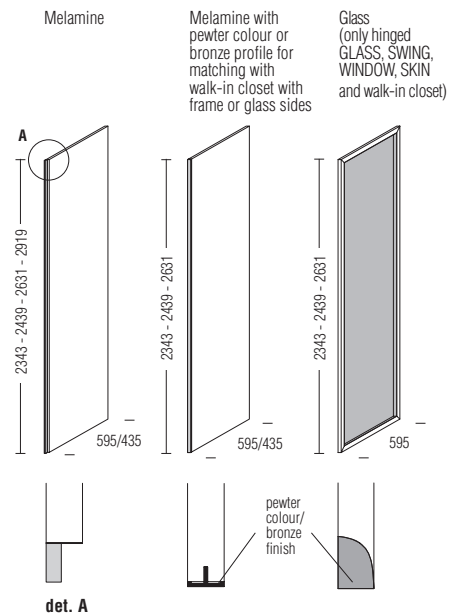

### DATASHEET

REGISTERED  
DESIGN

IX.2018

## WARDROBE REDUCTIONS

### Structure reductions

Type of reduction	height	width	depth
Linear modules D 595 mm melamine back or fine grain back	per millimetre	per millimetre	min -20 mm max -256 wardrobe / flush sliding ward. max -160 mm
Linear modules D 595 mm glass back	per millimetre	no reductions	no reductions
Linear elements D 435 mm	per millimetre	per millimetre	min -20 mm max -96 mm
Corner element for wardrobe with doors	per millimetre	no reductions	no reductions
Corner element open or for GLASS/SWING doors	per millimetre	1 side up to 1101 x 1282	1 side up to mm 435
		2 sides up to 1101 x 1101	2 sides up to mm 435
Terminal element	per millimetre	no reductions	no reductions
Wooden central partition or side panel	per millimetre		reductions depend on linear modules
Frame or glass side panel or central partition	per millimetre		no reductions

The retailer should remember to verify the stability of wardrobes having a depth inferior to 595 mm and arrange to have anti-tilt devices mounted if necessary.

### Door reductions

Type of reduction	height	width
Wooden hinged doors (START - TWIN - "A FILO" - GRIP - DEEP - NICHE)	per millimetre	per millimetre
"A FILO" glass hinged doors	per millimetre	per millimetre
Wooden sliding doors (START - "A FILO" - BLADE - GRIP - DEEP)	per millimetre	ONLY doors W 979 and 1307 mm - reducible down to W 815 mm
"A FILO" glass sliding doors	per millimetre	no reductions
Wooden flush sliding doors (START - TWIN - "A FILO" - GRIP - DEEP) Flush sliding doors W 1471 mm cannot be reduced.	per millimetre	no reductions
"A FILO" glass flush sliding doors	per millimetre	no reductions
SKIN doors	no reductions	no reductions
WINDOW / GLASS / SWING doors	per millimetre	reducible down to W 405 mm

### Reductions of internal fittings

Type of reduction	height	width	depth
Wood shelves		per millimetre	reductions depend on linear modules
Shelves with pewter colour profile		per millimetre	reductions depend on linear modules
Eco Skin shelves		per millimetre	reductions depend on linear modules
Glass shelves		per millimetre	reductions depend on linear modules
Clothes rails		per millimetre	
Central divider pieces	32 mm intervals		reductions depend on linear modules
Internal drawers / trinket trays, trouser holders and pull-out trays / grid with shirt and sweater holders / shoe rack shelves / pull-out shirt holders / lighting shelves / islands / movable trays	no reductions	no reductions	no reductions

\* If the corner shelves are reduced on two sides, consider double the cost.  
Lighting bars can be reduced with a surcharge included in the fee for cutting the shelf.

#### Cuts to measure

##### Diagonal cut doors (only for wardrobes with wooden sides)

When compiling the order, indicate the heights H1 and H2 and the width L as in the example.

The cost of a diagonal cut for each single door is the same as that for the hinged door in the table on page of the doors.

Compositions with diagonal slant are always built with single-door compartments. Only fitted with START, TWIN, "A FILO", GRIP or DEEP hinged doors. Doors must be hinged to the highest side panel. The door finish options for slanted wardrobes are restricted to cartapaglia, matt lacquer and matt lacquered cartapaglia. Structures can be either in standard sizes or customised.

##### Standard or cut-to-size doors (only for wardrobes with wooden sides)

For these solutions you can use either single or double units with hinged doors.

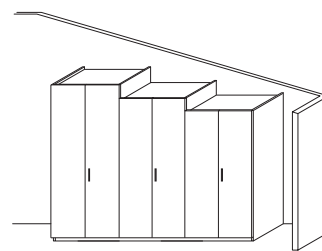
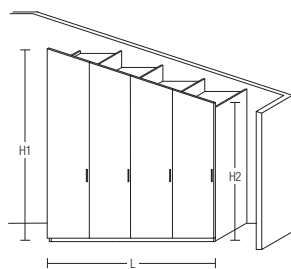

#### DATASHEET

REGISTERED  
DESIGN

IX.2018

GLISS  
MASTER—  
VINCENT  
VAN DUYSSEN  
2015

## GLASS TOP FOR WARDROBES FINISHED WITH ONLY ONE COMPARTMENT W 790/954

To use only with:  
- single linear module W 790 / W 954  
(no modular arrangement is possible)  
- only with glass lateral pieces and glass back panel

**Glass finish**  
transparent glass  
transparent stopsol glass  
stopsol glass

**Profile finish**  
pewter colour  
bronze

Molteni & C

12—  
41

Increase valid for depths 595 - 23 3/8"

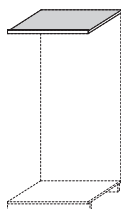

W 790 - 31 1/8"

W 954 - 37 1/2"

DATASHEET

REGISTERED  
DESIGN

IX.2018

[moltenigroup.com](http://moltenigroup.com)

Dimensions in millimeters and inches. The right to discontinue and make changes is reserved. This information is based on the latest product information available at the time of printing.

## START door th 25

Door with handles mounted on the front.

All the hinged doors have cushion-closing hinges.  
The sliding door have a shock absorber mechanism which allows them to open and close softly.  
**Hinges with 155° opening can be used and a key lock can be installed on hinged doors.**

### Handles

Type "E"  
Type "M"

### Notes

Sliding doors and flush sliding doors are not available in H 2889.

**With fronts in cartapaglia melamine, graffiato, silk and lacquered cartapaglia finishes, the outside of the side panel can be made with matt lacquer finish (in the same colour as the front), or in melamine in the same finish as the inside structure (if the side panel is not visible).**

# Molteni & C

13 —  
41

### START door

melamine cartapaglia  
melamine graffiato  
melamine silk  
matt lacquer colours  
cartapaglia lacquered colours  
glossy lacquer colours  
vertical grain wood

### Type "E"

standard

### Pewter colour structure with front insert:

pewter colour  
matt lacquer colours  
woods  
coloured glass  
etched coloured glass

### Structure and front insert:

shiny aluminium  
black chrome  
bronze

### Type "M"

surcharge for each

### Finish

pewter colour  
shiny aluminium  
black chrome  
bronze

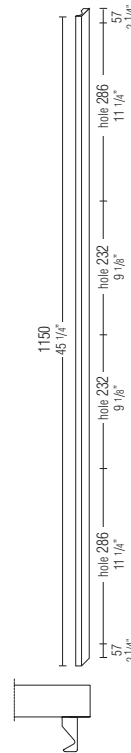
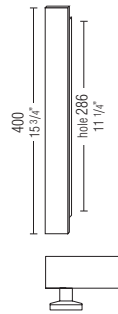
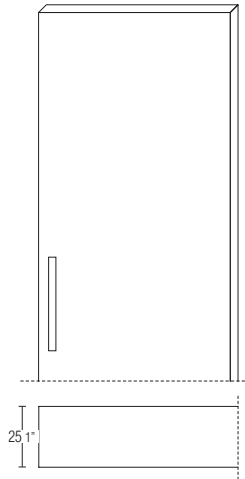

### finishes

melamine front    matt lacquer colours    cartapaglia lacquered colours    vertical grain wood    glossy lacquer colours

### hinged doors

width 487 (19 1/8")					
width 651 (25 5/8")					
width 815 (32 1/8")					
width 979 (38 1/2")					
width 1307 (51 1/2")					
door for terminal element					

### sliding doors

width 815 (32 1/8")					
width 979 (38 1/2")					
width 1307 (51 1/2")					
width 1471 (57 7/8")					

### flush sliding doors

width 815 (32 1/8")					
width 979 (38 1/2")					
width 1307 (51 1/2")					
width 1471 (57 7/8")					

### DATASHEET

REGISTERED  
DESIGN

IX.2018

## TWIN door th 25

Door with pewter colour or bronze finish handle mounted on the front.

All the hinged doors have cushion-closing hinges. The sliding door have a shock absorber mechanism which allows them to open and close softly.

**Hinges with 155° opening can be used and a key lock can be installed on hinged doors.**

### Notes

Flush sliding doors are not available in H 2889.

**With fronts in cartapaglia melamine, graffiato, silk and lacquered cartapaglia finishes, the outside of the side panel can be made with matt lacquer finish (in the same colour as the front), or in melamine in the same finish as the inside structure (if the side panel is not visible).**

Molteni & C

### TWIN door

melamine cartapaglia  
melamine graffiato  
melamine silk  
matt lacquer colours  
cartapaglia lacquered colours  
glossy lacquer colours  
vertical grain wood

### Handle finish

pewter colour  
bronze

14—  
41

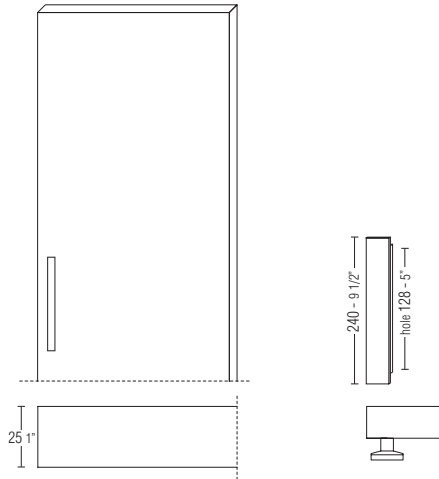

### finishes

melamine front    matt lacquer colours    cartapaglia lacquered colours    vertical grain wood    glossy lacquer colours

#### hinged doors

width 487 (19 1/8")					
width 651 (25 5/8")					
width 815 (32 1/8")					
width 979 (38 1/2")					
width 1307 (51 1/2")					
door for terminal element					

#### flush sliding doors

width 815 (32 1/8")					
width 979 (38 1/2")					
width 1307 (51 1/2")					
width 1471 (57 7/8")					

### DATASHEET

REGISTERED  
DESIGN

IX.2018

**“A FILO” door th 25**

Door with full-height handle included in the thickness of the door.  
 The door is available in the versions wood and glass.

All the hinged doors have cushion-closing hinges.  
 The sliding door have a shock absorber mechanism which allows them to open and close softly.  
**Hinges with 155° opening can be used and a key lock can be installed on hinged doors.**

**Notes**

Sliding doors and flush sliding doors are not available in H 2889.  
 Glass hinged doors are not available in H 2889.  
 Flush sliding glass doors cannot be used in compositions with 3 doors.

**With fronts in cartapaglia melamine, graffiato, silk and lacquered cartapaglia finishes, the outside of the side panel can be made with matt lacquer finish (in the same colour as the front) or in melamine in the same finish as the inside structure (if the side panel is not visible).**

**Molteni & C**

**“A FILO” wooden door**

- melamine cartapaglia
- melamine graffiato
- melamine silk
- matt lacquer colours
- cartapaglia lacquered colours
- glossy lacquer colours
- vertical grain wood

**“A FILO” glass door**

- Glass:
- coloured
- etched coloured
- mirror

- Profile and “a filo” handle:
- pewter colour
- bronze

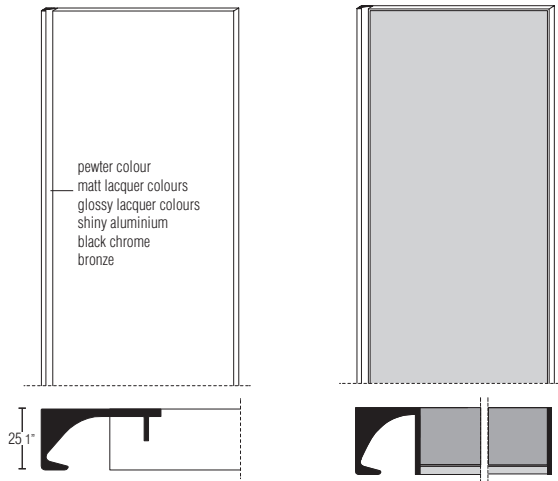

**finishes**

	melamine front	matt lacquer colours	cartapaglia lacquered colours	vertical grain wood	glossy lacquer colours	coloured glass/ etched coloured glass/ mirror
<b>hinged doors</b>						
width 487 (19 1/8")						
width 651 (25 5/8")						
width 815 (32 1/8")						
width 979 (38 1/2")						
width 1307 (51 1/2")						
door for terminal element						
<b>sliding doors</b>						
width 815 (32 1/8")						
width 979 (38 1/2")						
width 1307 (51 1/2")						
width 1471 (57 7/8")						
<b>flush sliding doors</b>						
width 815 (32 1/8")						
width 979 (38 1/2")						
width 1307 (51 1/2")						
width 1471 (57 7/8")						

**DATASHEET**

REGISTERED  
 DESIGN

IX.2018

**BLADE sliding door th 25**

Door with full-height handle.

The sliding system automatically aligns the door as it opens and closes.

**Notes**

BLADE doors are not available with H 2889.

**With fronts in cartapaglia melamine, graffiato, silk and lacquered cartapaglia finishes, the outside of the side panel can be made with matt lacquer finish (in the same colour as the front), or in melamine in the same finish as the inside structure (if the side panel is not visible).**

**Molteni & C**

16—  
 41

**BLADE sliding door**  
 melamine cartapaglia  
 melamine graffiato  
 melamine silk  
 matt lacquer colours  
 cartapaglia lacquered colours  
 glossy lacquer colours  
 vertical grain wood

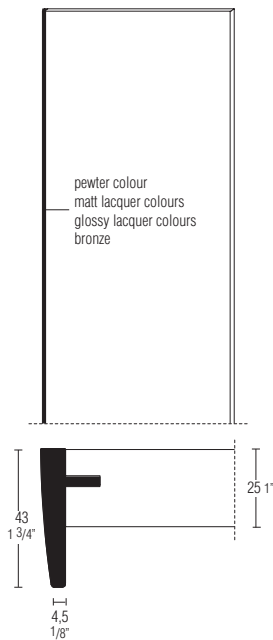

sliding doors	finishes				
	melamine front	matt lacquer colours	cartapaglia lacquered colours	vertical grain wood	glossy lacquer colours
width 815 (32 1/8")					
width 979 (38 1/2")					
width 1307 (51 1/2")					
width 1471 (57 7/8")					

**DATASHEET**

REGISTERED  
 DESIGN

IX.2018

## GRIP door th 25 DESIGN VINCENT VAN DUYSSEN

Door with a handle applied laterally on the edge of the door.

All the hinged doors have cushion-closing hinges.  
The sliding door have a shock absorber mechanism which allows them to open and close softly.  
**Hinges with 155° opening can be used on hinged doors.**

### Notes

Sliding doors and flush sliding doors are not available in H 2889.

**In the pair of hinged doors, the handle is mounted on both doors in the pair.**

**With fronts in cartapaglia melamine, graffiato, silk and lacquered cartapaglia finishes, the outside of the side panel can be made with matt lacquer finish (in the same colour as the front), or in melamine in the same finish as the inside structure (if the side panel is not visible).**

### Handles finishes

pewter colour

bronze

pewter colour covered in Eco Skin in the colours (with surcharge per handle)

bronze covered in Eco Skin in the colours (with surcharge per handle)

# Molteni & C

17—  
41

**GRIP door**  
melamine cartapaglia  
melamine graffiato  
melamine silk  
matt lacquer colours  
cartapaglia lacquered colours  
glossy lacquer colours  
vertical grain wood

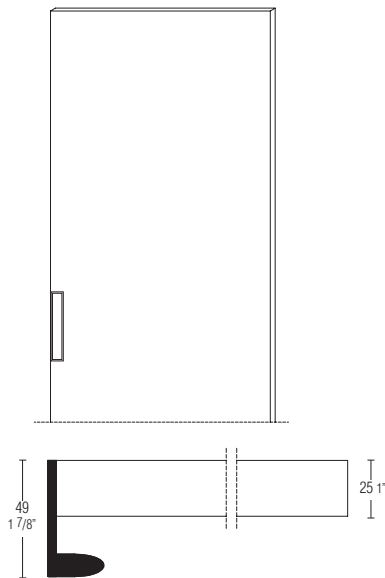

### finishes

	melamine front	matt lacquer colours	cartapaglia lacquered colours	vertical grain wood	glossy lacquer colours
<b>hinged doors</b>					
width 487 (19 1/8")					
width 651 (25 5/8")					
width 815 (32 1/8")					
width 979 (38 1/2")					
width 1307 (51 1/2")					
door for terminal element					
<b>sliding doors</b>					
width 815 (32 1/8")					
width 979 (38 1/2")					
width 1307 (51 1/2")					
width 1471 (57 7/8")					
<b>flush sliding doors</b>					
width 815 (32 1/8")					
width 979 (38 1/2")					
width 1307 (51 1/2")					
width 1471 (57 7/8")					

DATASHEET

REGISTERED  
DESIGN

IX.2018

**DEEP door th 25** DESIGN VINCENT VAN DUYSSEN

Door with recessed handle.

All the hinged doors have cushion-closing hinges.  
The sliding door have a shock absorber mechanism which allows them to open and close softly.  
**Hinges with 155° opening can be used on hinged doors.**

**Notes**

Sliding doors and flush sliding doors are not available in H 2889.

**In the pair of hinged doors, the handle is mounted on both doors in the pair.**

**With fronts in cartapaglia melamine, graffiato, silk and lacquered cartapaglia finishes, the outside of the side panel can be made with matt lacquer finish (in the same colour as the front) or in melamine in the same finish as the inside structure (if the side panel is not visible).**

**Handles finishes**

pewter colour  
bronze  
pewter colour covered in Eco Skin in the colours (with surcharge per handle)  
bronze covered in Eco Skin in the colours (with surcharge per handle)

Molteni & C

18—  
41

**DEEP door**  
melamine cartapaglia  
melamine graffiato  
melamine silk  
matt lacquer colours  
cartapaglia lacquered colours  
glossy lacquer colours  
vertical grain wood

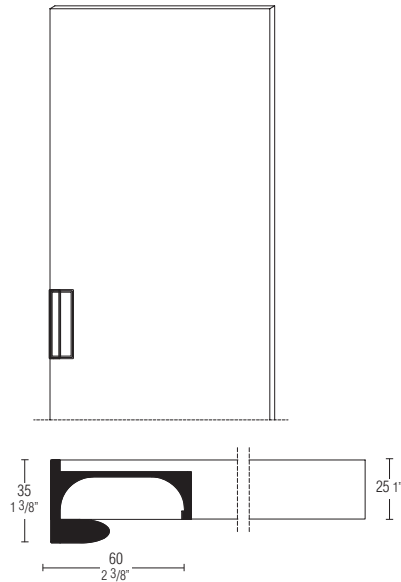

**finishes**

	melamine front	matt lacquer colours	cartapaglia lacquered colours	vertical grain wood	glossy lacquer colours
<b>hinged doors</b>					
width 487 (19 1/8")					
width 651 (25 5/8")					
width 815 (32 1/8")					
width 979 (38 1/2")					
width 1307 (51 1/2")					
door for terminal element					

**sliding doors**

width 815 (32 1/8")					
width 979 (38 1/2")					
width 1307 (51 1/2")					

**flush sliding doors**

width 815 (32 1/8")					
width 979 (38 1/2")					
width 1307 (51 1/2")					

**DATASHEET**

REGISTERED  
DESIGN

IX.2018

**NICHE door th 25** DESIGN VINCENT VAN DUYSSEN

Door with recessed handle.

All the hinged doors have cushion-closing hinges.

**Hinges with 155° opening can be used on hinged doors.**

**Handles finishes**

pewter colour  
 bronze

**Molteni & C**

**NICHE door**  
 matt lacquer colours  
 glossy lacquer colours  
 vertical grain wood

**19**—  
 41

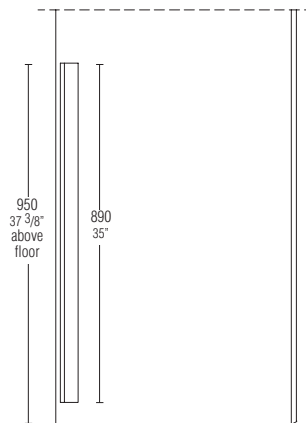

**finishes**

matt lacquer colours      vertical grain wood      glossy lacquer colours

**hinged doors**

	matt lacquer colours	vertical grain wood	glossy lacquer colours
width 487 (19 1/8")			
width 651 (25 5/8")			
width 815 (32 1/8")			
width 979 (38 1/2")			
width 1307 (51 1/2")			
door for terminal element			

**DATASHEET**

REGISTERED  
 DESIGN

IX.2018

GLISS  
MASTER—  
VINCENT  
VAN DUYSSEN  
2015

## GLASS door, th 35, 180° opening DESIGN VINCENT VAN DUYSSEN

Glass door with 180° opening made with a special soft close hinge inserted in the profile and completely hidden in the side (exclusively by Molteni).  
A full height handle is designed in the profile.

### Notes

GLASS doors are not available in H 2889.

**In the pair of hinged doors, the handle is mounted on both doors in the pair.**

**The GLASS door can also be installed on the open corner module.**

# Molteni & C

### GLASS door

20—

41

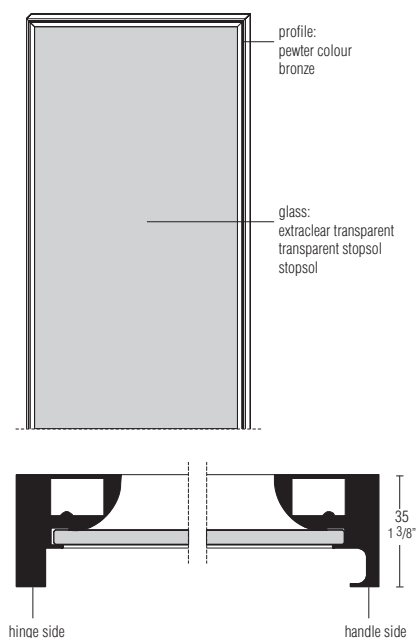

### DATASHEET

REGISTERED  
DESIGN

IX.2018

[moltenigroup.com](http://moltenigroup.com)

Dimensions in millimeters and inches. The right to discontinue and make changes is reserved. This information is based on the latest product information available at the time of printing.

## SWING door, th 35, 180° opening DESIGN VINCENT VAN DUYSSEN

Matt lacquered door with panel and perimeter profiles with a 180° opening made with a special soft close hinge inserted in the profile and completely hidden in the side (exclusively by Molteni).

### Notes

SWING doors are not available in H 2889.

**In the pair of hinged doors, the handle is mounted on both doors in the pair.**

**The SWING door can also be installed on the open corner module.**

# Molteni & C

### SWING door

21—

41

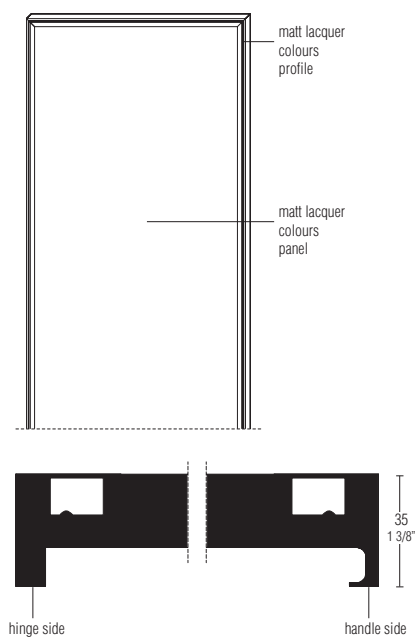

### DATASHEET

REGISTERED  
DESIGN

IX.2018

## WINDOW door th 30 DESIGN VINCENT VAN DUYSSEN

Glass hinged door with pewter colour finished aluminium frame and lateral handle.

The doors are fitted with recessed hinges inserted in the base and top.

### Notes

WINDOW doors are not available in H 2889.

In the pair of hinged doors, the handle is mounted on both doors in the pair.

### Handle finishes

pewter colour

bronze

pewter colour covered in Eco Skin in the colours (with surcharge per handle)

bronze covered in Eco Skin in the colours (with surcharge per handle)

# Molteni & C

WINDOW glass door

22—

41

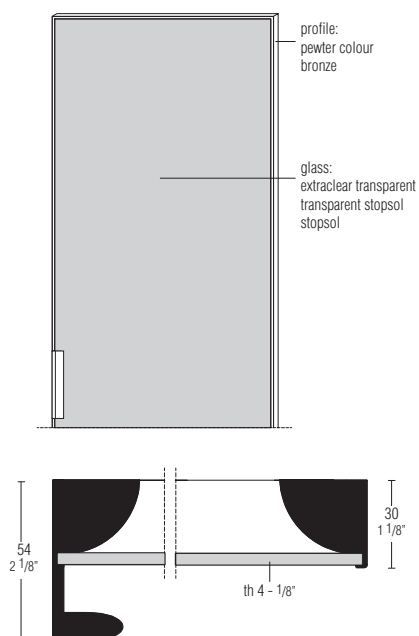

### DATASHEET

REGISTERED  
DESIGN

IX.2018

**SKIN hinged door th 30** DESIGN VINCENT VAN DUYSSEN

Eco Skin covered hinged door with pewter colour and bronze finished aluminium frame and lateral handle.

**The doors are fitted with recessed hinges inserted in the base and top.**

The door is always divided into 3 equal parts.

**Notes**

SKIN doors are not available in H 2889.

**In the pair of doors, the handle is mounted on both doors in the pair.**

**Handle finishes**

pewter colour

bronze

pewter colour covered in Eco Skin in the colours (with surcharge per handle)

bronze covered in Eco Skin in the colours (with surcharge per handle)

**SKIN hinged door**

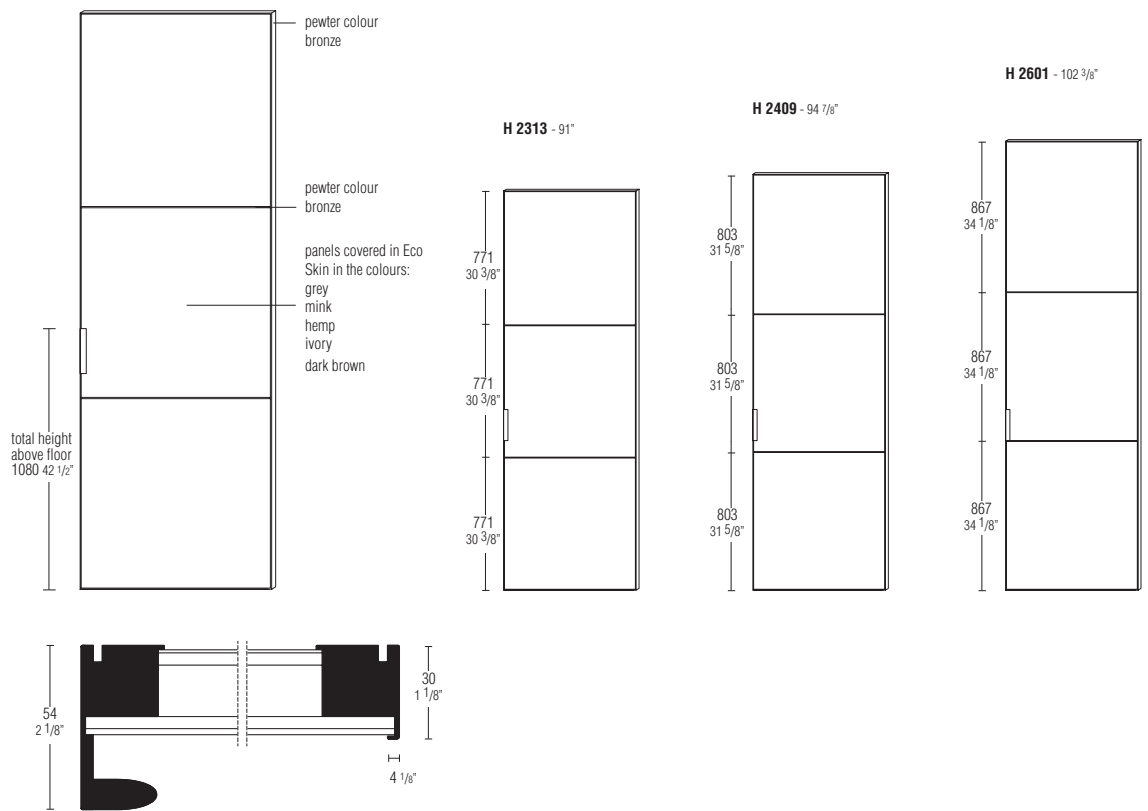

**DATASHEET**

REGISTERED  
 DESIGN

IX.2018

## SPECIAL ELEMENTS

### Column with open compartment

- Can be inserted only in wardrobes without doors or with hinged doors.
- Central partitions and/or lateral pieces close the column and cannot be frame or glass.
- The open compartment is always in matt lacquered colours.
- Doors are always without handles because they protrude with respect to the structure.
- Drawers are fitted with the "E" handle of the START door.
- Front finish: melamine front, matt lacquered colours, glossy lacquered colours and wood.

\* **The price does not include the central partitions or side panels, nor the internal shelves.**

### Reductions

Reductions are allowed only in height, and costs of cutting the structure and doors are applied. Open compartment and lower part cannot be reduced.

Wire passage **EPA1** Ø 60 chrome on request on back.

### Notes

The back of the open compartment cannot hold a mounted TV.

# Molteni & C

24 —  
 41

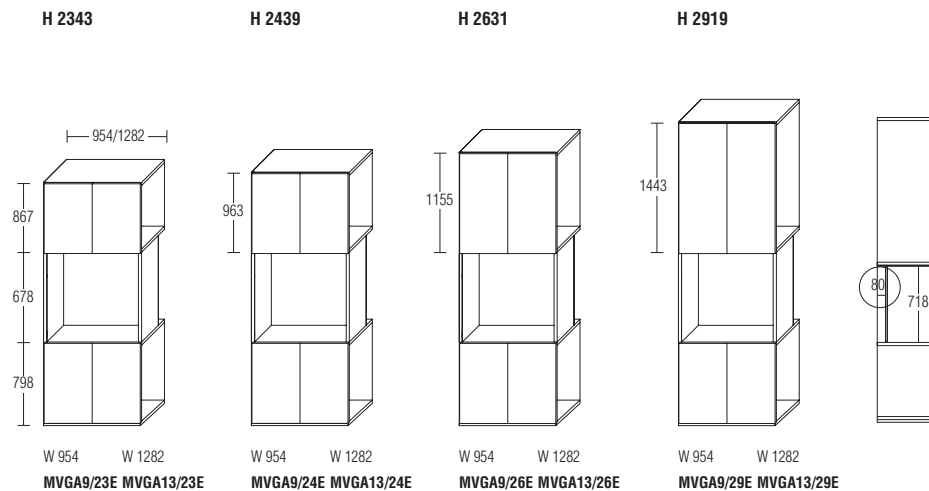
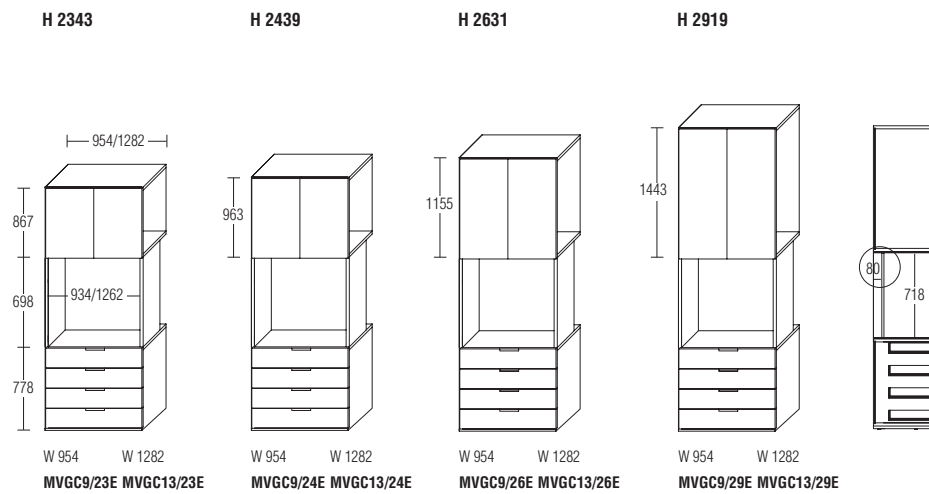

### DATASHEET

REGISTERED  
 DESIGN

IX.2018

## SPECIAL ELEMENTS

### Column with external drawers

- Can be inserted only in wardrobes with hinged doors.
- Central partitions and/or lateral pieces close the column and cannot be frame or glass.
- Pairs of doors always have only one handle mounted on the right door.
- Drawers are fitted with the "E" handle of the START door.
- Front finish: melamine front, matt lacquered colours, glossy lacquered colours and wood.

### Reductions

Reductions are allowed only in height, and costs of cutting the structure and doors are applied.

\* The price does not include the central partitions or side panels, nor the internal shelves.

# Molteni&C

25—  
 41

### Doors with type "E" handle

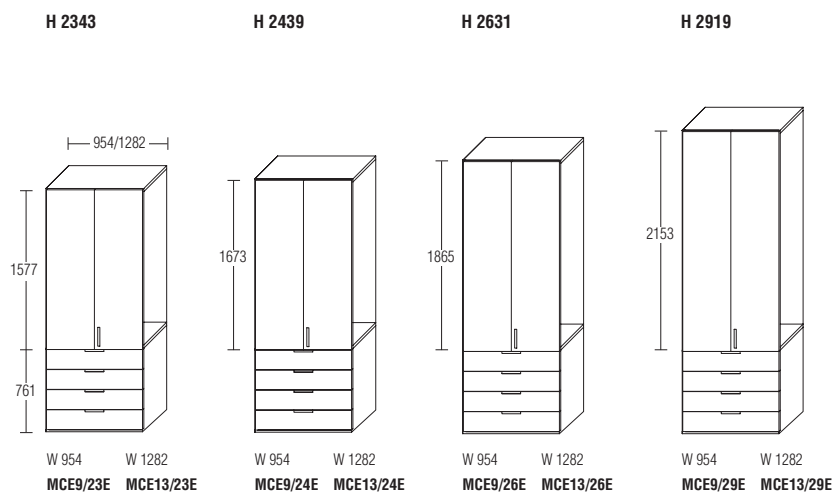

### Doors with "A FILO" handle

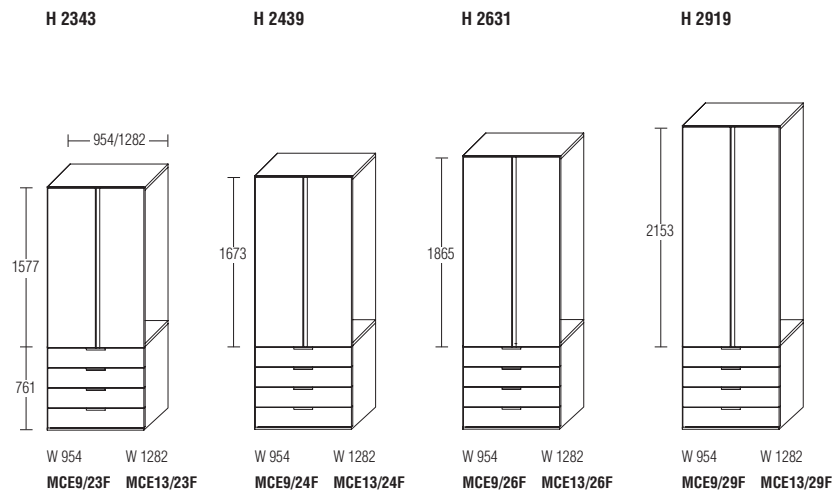

### DATASHEET

REGISTERED  
 DESIGN

IX.2018

## FILLERS AND OPENING SIDE TRIMS

### Horizontal filler

The filler is supplied in two parts, one part to be fixed to the ceiling to which the other will be hooked on (see diagram below).

The distance of the filler from the door is the client's decision.

In the cartapaglia finish, the grain direction is always vertical.

In the wood and graffiato finish, the grain direction is always horizontal.

### Vertical filler

The vertical filler can be placed flush with the structure or the door.

This detail must be specified in the order to prepare the side panel (see example).

If this detail is not specified when placing the order, the filler will automatically be placed flush with the structure and the side panel will have the extension profile.

### Opening fillers

Can be made with START and "A FILO" door. For handles, see surcharge.

Always have the 155° hinges.

Are the same height as the other doors in the composition.

Have a closing strip on their lower part.

In the wood finish, the grain direction is always vertical.

Horizontal filler side sections

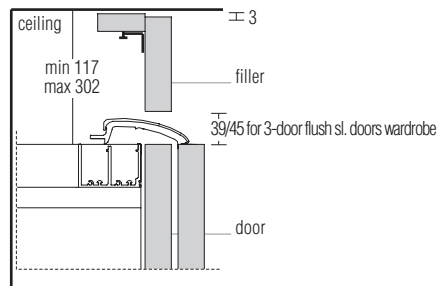
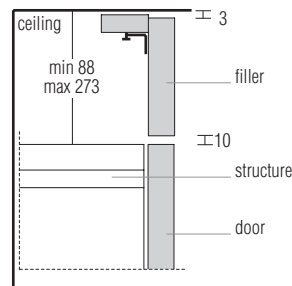

Vertical filler horizontal sections

Flush with structure

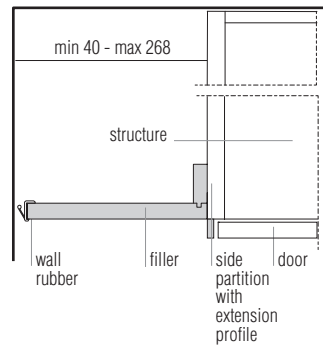

Flush with door

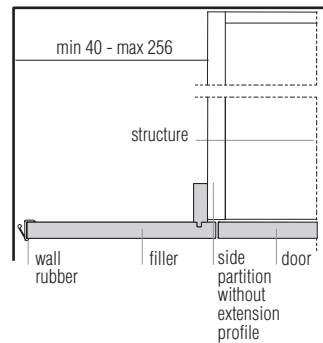

Set back

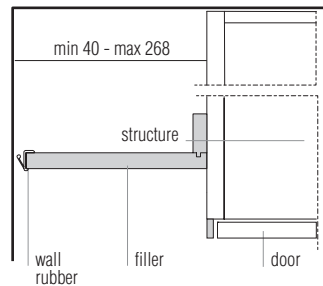

Opening filler horizontal sections

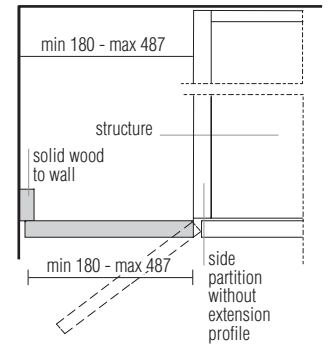

**DATASHEET**

REGISTERED  
 DESIGN

IX.2018

## LIGHTING SYSTEM

### Lighting bars with front LEDs

Internal compartments of Gliss Master wardrobes can be equipped with front LED lighting. The lighting bar can be applied to lids or to wooden, transparent glass and Eco Skin shelves. Using the electrified wire strip installed on the side (wood, frame or glass), the shelf can be moved. For each compartment length, we have made specific lighting bars with wiring compliant with European safety standards.

A wire strip is not needed if the compartment only has lighting on the top piece.

**Lighting bars can be reduced with a surcharge for the shelf cutting.**

### Lighting shelves

It is possible to insert one or more lighting shelves in Gliss Master compartments.

Using the electrified wire strip mounted on the side panel, the lighting shelf can be moved.

**Lighting shelves can be connected to the wire strip on the left side panel or can be mounted without wire strip.**

### Notes

When placing the order, the customer must indicate how many shelves with lighting bars or lighting shelves are required. Lighting bars or lighting shelves can be placed in the same compartment. **For assembly: a lighting system on wardrobe with hinged doors requires a minimum extra height of 5 cm (2").**

**Individual wire strip is always installed on the left side panel of the compartment, with the exception of corner units for walk-in wardrobes and of the compartment next to the corner unit.**

**When ordering, indicate compartments with wire strip.**

Molteni & C

27—  
41

<b>lighting bars</b> 3000 K	W 462	W 626	W 790	W 954	W 1282	open corner element
	6 watt	8 watt	10 watt	12 watt	16 watt	20 watt



<b>lighting shelves</b> D 538 th 30 3000 K	W 626	W 790	W 954	W 1282
	12 watt	15 watt	18 watt	30 watt



**components per system**  
(see the diagram for component use and to calculate system cost)

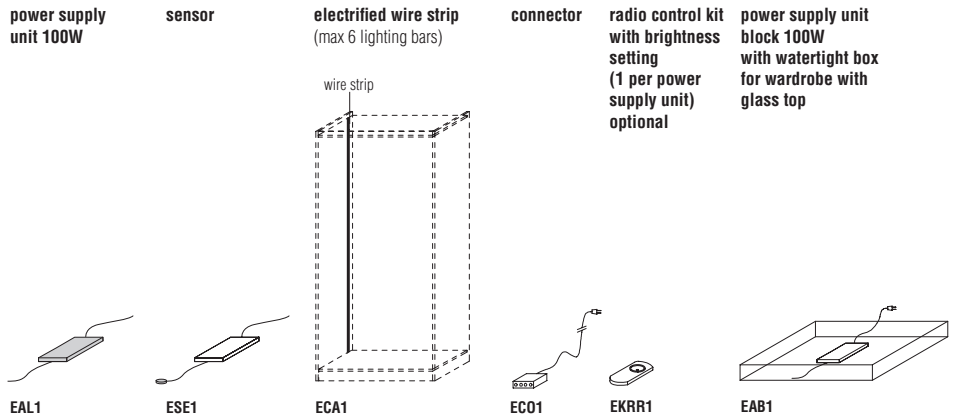

**position of bar and wire strip on wooden partitions**

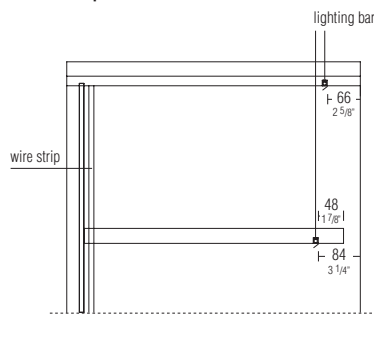

**position of bar and wire strip on glass partitions**

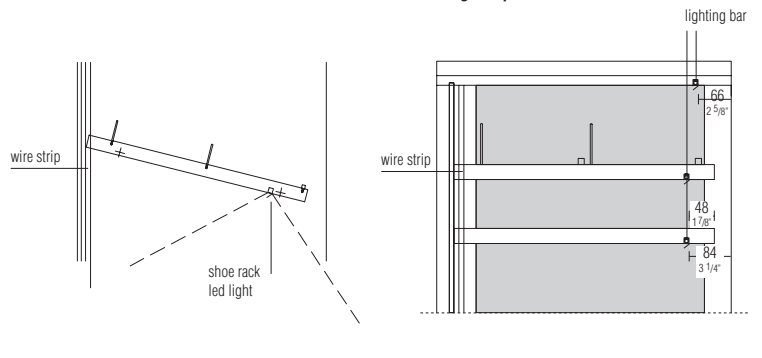

**DATASHEET**

REGISTERED  
DESIGN

IX.2018

## LIGHTING SYSTEM

### System construction diagram

A composition (wardrobe) can be equipped with more than one system and more than one power supply unit. The system with sensor must be autonomous from the system with remote controlled electrical socket.

#### types of systems with sensors

#### system with sensor + wire strip suggested for wardrobes with doors

#### system with sensor (not for use with glass backs) suggested for wardrobes with doors and bars positioned only on the top piece

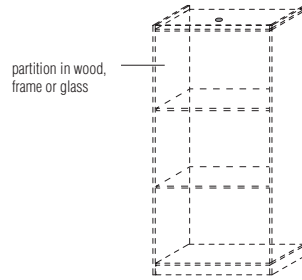
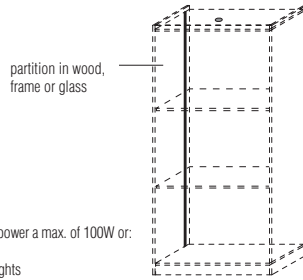

★ each power supply unit can power a max. of 100W or:  
max 6 sensors  
max 6 wire strip or 6 LED lights

sensor (1 per compartments)	●	●
power supply unit (per composition ★)	●	●
wire strips on lateral pieces (per compartment)	●	
connector (for compositions of 4 power supply units max.)	●	●

#### types of systems with remote control electrical socket or radio remote control

one radio remote control unit can control systems with 2 power supply units max. Otherwise, more radio remote control units must be used.

#### system with wire strip for remote control electrical socket suggested for wardrobes without doors (walk-in wardrobes) and glass doors

#### system with remote control electrical socket (not for use with glass backs) suggested for wardrobes without doors (walk-in wardrobes) and glass doors

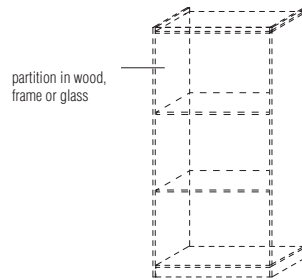
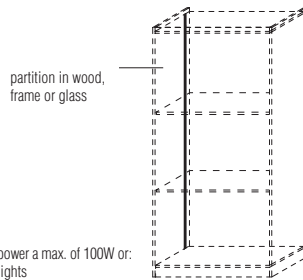

★ each power supply unit can power a max. of 100W or:  
max 6 wire strips or 6 LED lights

power supply unit (per composition ★)	●	●
wire strips on lateral pieces (per compartment)	●	
connector (for compositions of 4 power supply units max.)	●	●
radio remote control (optional)	● (optional)	● (optional)

#### DALI kit (for DOMOTICA)

n. 1 for each power supply unit  
cannot be used with  
radio remote control

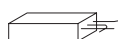

EKDA1

Molteni & C

28—  
41

#### DATASHEET

REGISTERED  
DESIGN

IX.2018

moltenigroup.com

Dimensions in millimeters and inches. The right to discontinue and make changes is reserved. This information is based on the latest product information available at the time of printing.

## INTERNAL ACCESSORIES

Aircub is an air purifier and aroma diffuser that eliminates up to 95% of the harmful agents inside wardrobes through a process of ionisation and ozonation. Aircub can be managed easily from your smartphone with a dedicated app. Aircub can be installed on the back panel of each compartment. Just plug it into the electrical socket and turn it on. Every Aircub has a single plug. Up to 3 Aircubs per wardrobe can be installed using the specific multi-socket connector.

**Aircub - air purifier**  
W 270 D 28 H 120  
W 10 5/8" D 1 1/8" H 4 3/4"  
(cable length L3m)

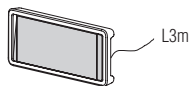

EAC1

### product advantages

- improves air quality
- reduces bacteria that cause foul odours
- prevents mould and miles from forming
- dispenses fragrance
- does not have filters that require maintenance or changes
- includes n.1 fragrance pod

**multi-socket connector**  
cable length 3m  
W 250 D 60 H 40  
W 9 7/8" D 2 3/8" H 1 5/8"

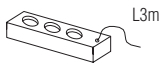

EAC2

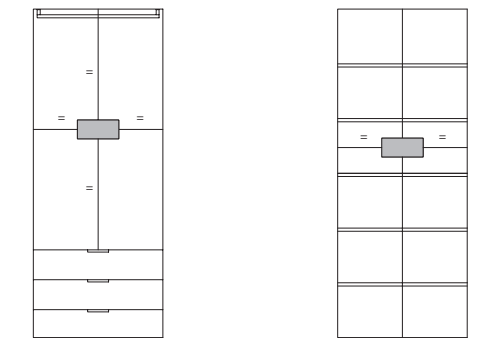

**For correct function it is advisable  
to position the Aircub at the centre  
of the compartment**

## DATASHEET

REGISTERED  
DESIGN

IX.2018

## INTERNAL FITTINGS

Internal fittings  
with wooden sides

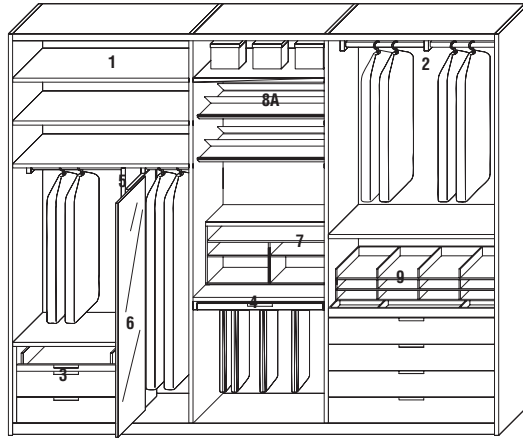

Internal fittings  
with frame or glass sides

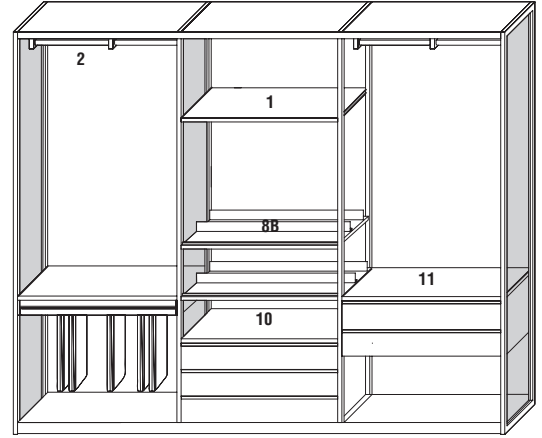

- 1** Shelf th 30 mm (wood, glass, Eco Skin)
- 2** Clothes rail
- 3** Modular drawer unit only for wooden sides
- 4** Trousler holder
- 5** Central divider piece th mm 30 only for compart. with wooden sides
- 6** Swivel pull-out mirror only for compart. with wooden sides
- 7** Shirt and sweater holder grid only for wood sides
- 8A** Inclined shoe rack shelf only for wooden sides
- 8B** Horizontal shoe rack shelf only for frame or glass sides
- 9** Pull-out shirt holder only for wooden sides
- 10** Floor standing drawer unit only for compart. with frame or glass sides
- 11** Suspended drawer unit only for compart. with frame or glass sides

### Section of internal fittings

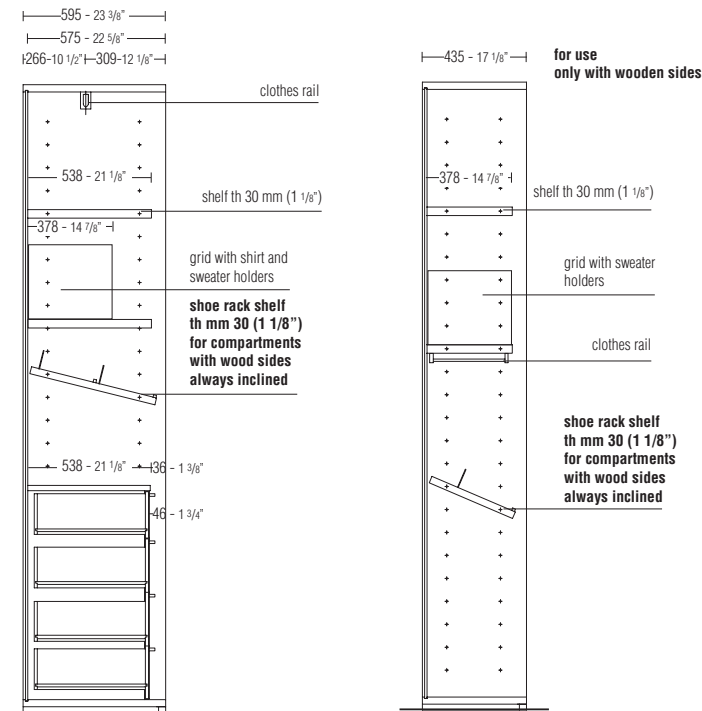

Molteni & C

30—  
41

### DATASHEET

REGISTERED  
DESIGN

IX.2018

## INTERNAL FITTINGS - SHELVES, SHOE RACK SHELVES

Molteni & C

31—  
41

### wood shelves - top shelves (only D 538)

D 538 th 30  
D 378 th 30



W 298	W 462	W 626	W 790	W 954	W 1282
<b>RI/3</b>	<b>RI/4</b>	<b>RI/6</b>	<b>RI/8</b>	<b>RI/9</b>	<b>RI/13</b>

### shelf for open corner element th 30

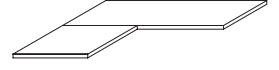

1081x1081	1262x1262
<b>RIA/11</b>	<b>RIA/13</b>

glass shelves can be fitted with front LED light bars and comply with the wiring standards

### transparent glass shelves

D 538 th 30  
D 378 th 30



W 462	W 626	W 790	W 954	W 1282
<b>RV/4</b>	<b>RV/6</b>	<b>RV/8</b>	<b>RV/9</b>	<b>RV/13</b>

not for use in compartments adjacent to the corner element in wardrobes with doors

Eco Skin shelves can be fitted with front LED light bars and comply with the wiring standards

### Eco Skin shelves - shelves with Eco Skin cover (only D 538)

D 538 th 30  
D 378 th 30

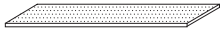

W 298	W 462	W 626	W 790	W 954	W 1282
<b>RE/3</b>	<b>RE/4</b>	<b>RE/6</b>	<b>RE/8</b>	<b>RE/9</b>	<b>RE/13</b>

### Eco Skin shelf for open corner element th 30

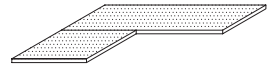

1081x1081	1262x1262
<b>REA/11</b>	<b>REA/13</b>

When ordering, specify the finish Eco Skin and profile

### Shoe rack shelves

Shoe rack shelves can be used with wood sides and with frame or glass sides. When inserted between wood sides, this part will always be inclined (example 1). When there are frame or glass sides, this part will always be horizontal (example 2).

### Notes

To hook to the frame or glass sides, add the price of the relative metal profiles.

#### example 1

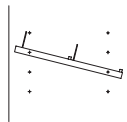

### shoe rack shelves

D 538 th 30

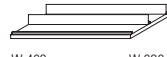

W 462	W 626	W 790	W 954	W 1282
<b>RSP/4</b>	<b>RSP/6</b>	<b>RSP/8</b>	<b>RSP/9</b>	<b>RSP/13</b>

#### example 2

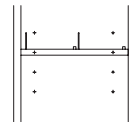

#### example 1

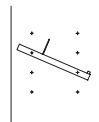

### shoe rack shelves

D 368 th 30



W 462	W 626	W 790	W 954	W 1282
<b>RQP/4</b>	<b>RQP/6</b>	<b>RQP/8</b>	<b>RQP/9</b>	<b>RQP/13</b>

metal profile for attaching shelves to frame side



PST

metal profile for attaching shelves to glass side



PSV

metal profile for attaching shelves with LEDs to frame side (always on the left, except in corner shelves)



PSE

DATASHEET

REGISTERED  
DESIGN

IX.2018

moltenigroup.com

Dimensions in millimeters and inches. The right to discontinue and make changes is reserved. This information is based on the latest product information available at the time of printing.

## INTERNAL FITTINGS - CLOTHES RAILS, HANGER RAILS, PULL-DOWN HANGERS, CENTRAL DIVIDER PIECES

Molteni & C

32—  
 41

### clothes rails



W 298 W 462  
**PO/3 PO/4**

W 626

W 790

W 954

W 1282



### clothes rail for corner compartment with doors

**POA/6**

### clothes rail for D 435

to mount on wood shelves or top only with hinged doors

nr. 1 piece on compartment W 626/790  
 nr. 2 pieces on compartment W 954/1282



**POQ/4**

### clothes rails for open corner compartment

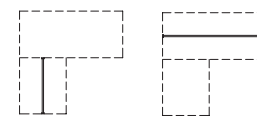

W 723

**POA/7**

W 1262

**POA/13**

### pull-out coat hanger rail

for melamine shelf (without profile) th 30



**OP7**

### hanger W 450

beech stained grey  
 (package of 10 pieces)



**OP10**

### hanger with clips W 450

beech stained grey  
 (package of 3 pieces)



**OP11**

Maximum load-bearing capacity 10 kg

### pull-down hanger

H mm 1040  
 for compart. W 626

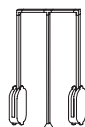

**SER/6**

for compart. W 790

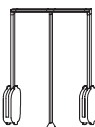

**SER/8**

for compart. W 954

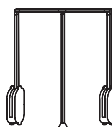

**SER/9**

for compart. W 1282

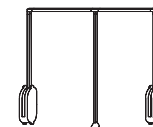

**SER/13**

When ordering, specify the finish of the front profile: pewter colour or bronze

### floor standing central divider pieces

D 538 th 30



**SDT/04**

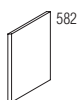

**SDT/05**

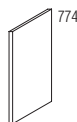

**SDT/07**



**SDT/09**

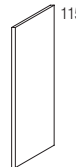

**SDT/11**

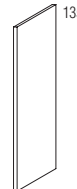

**SDT/13**

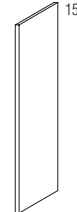

**SDT/15**



**SDT/17**

DATASHEET

REGISTERED DESIGN

IX.2018

[moltenigroup.com](http://moltenigroup.com)

Dimensions in millimeters and inches. The right to discontinue and make changes is reserved. This information is based on the latest product information available at the time of printing.

## GLASS LID FOR CHEST OF DRAWERS

### To be used only in compartments with wooden sides

Modular chests of drawers can be made with a transparent glass lid in the module widths 790/954/1282.

It is mandatory that the first drawer be H 190 in wood (special measure).

The top can be fitted with a LED lighting bar, but it cannot be connected to the cable holder.

The connection to the power cord has to pass behind the back panel.

Eco Skin bottoms in grey can be inserted.

# Molteni & C



W 790  
**CSV/08**

W 954  
**CSV/09**

W 1282  
**CSV/13**

33—

41

### Example of use

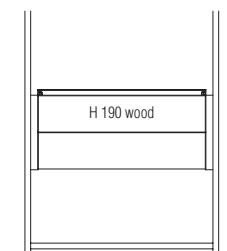

DATASHEET

REGISTERED  
DESIGN

IX.2018

## INTERNAL FITTINGS - MOVABLE TRAYS SET

### Only for use in compartments with wooden sides

These units can be positioned on the floor-standing drawer units or suspended over a drawer H 190 of the same dimensions as the unit (see ex. 1).  
 The price of the blocks does not include the shelf covering the drawer unit.

### Finishes

The trays are always made in melamine in the finish of the structure with bottom in grey Eco Skin.  
 The trinket tray is always dolomite lacquered.

### example 1

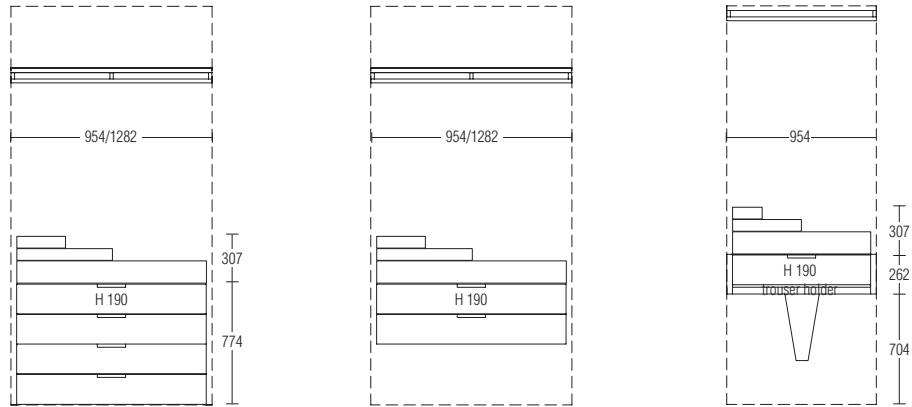

Molteni & C

34—  
 41

The price of the blocks does not include the shelf covering the drawer unit

for compartment  
 W 954

for compartment  
 W 1282

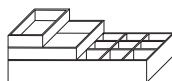

**BVS9/03/1**

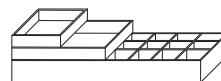

**BVS13/03/1**

### DATASHEET

REGISTERED  
 DESIGN

IX.2018

**INTERNAL FITTINGS - PULL-OUT SHIRT HOLDER - GRID WITH SHIRT AND SWEATER HOLDERS**

**Pull-out shirt holder  
 only for use in compartments with wooden sides**

These units can be positioned on the floor-standing drawer units or suspended over a drawer H 190 of the same dimensions as the shirt unit (see ex. 1).

**Finishes**

The tray set on top of the shelf is always finished in melamine in the same finish as the structure with Eco Skin bottom grey finish.  
 The shirt holder grid is always dolomite lacquered.

**example**

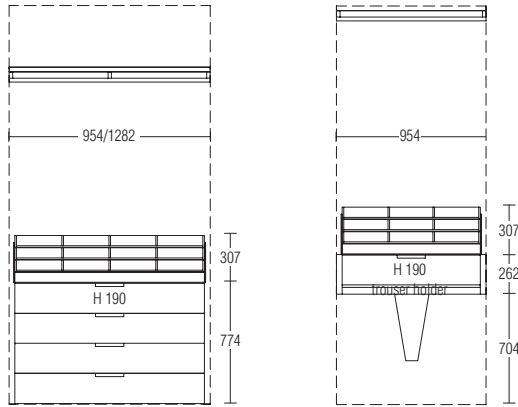

When ordering, specify the finishes of the trays set on shelves and the shirt holder grid

for compartment  
 W 954  
 including resting shelf

for compartment  
 W 1282  
 including resting shelf

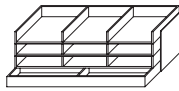

**BPC9/03/1**

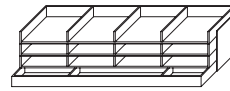

**BPC13/03/1**

**Grid with shirt and sweater holders**

These elements are fixed and to be used set on shelves or on drawer units.  
 Only in compartments with wood sides.

**Grid with shirt and sweater holders**

W 626 D 378 H 480

W 790 D 378 H 480

W 954 D 378 H 480

W 1282 D 378 H 480

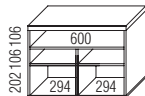

**BGR6/05/1**



**BGR8/05/1**

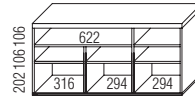

**BGR9/05/1**

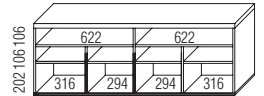

**BGR13/05/1**

**Examples of use**

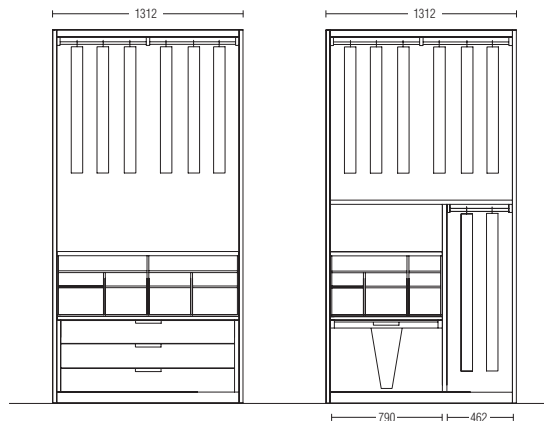

**INTERNAL FITTINGS - MIRRORS**

**Procedure for using the swivel pull-out mirror**

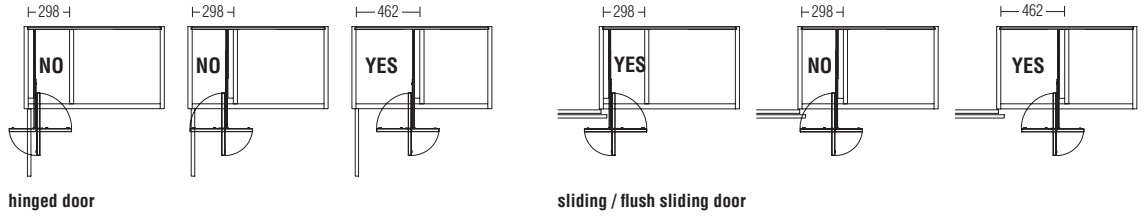

**Molteni & C**

**36**—  
 41

**mirror**  
 applied to inside of  
 hinged door  
 W 315 H 1600 th 4

**swivel pull-out mirror**  
 to be applied onto the side,  
 partition or central divider pieces  
 D 555 H 1443 th 90



**SPECH**

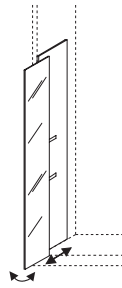

**SPECS/17**

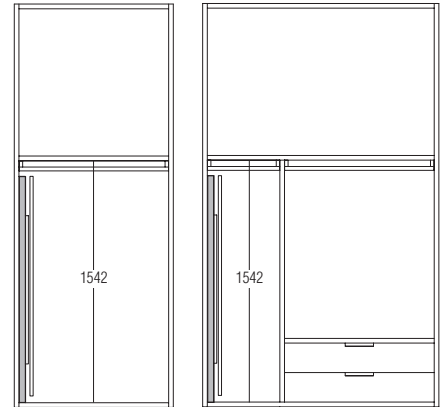
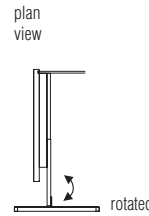

**DATASHEET**

REGISTERED  
 DESIGN

IX.2018

## INTERNAL FITTINGS - MODULAR DRAWERS AND TRAYS

### Notes

The parts of this internal fittings are produced with width and height dimensions corresponding to the modular compartments. This makes it possible to organise the internal spaces in a number of ways. To correctly and quickly determine the internal fittings, some of the possible compositions are in the following pages.

The pairs of side panels suspended or resting on the floor are essential for inserting all the elements.

Compositions must be completed with a top shelf.

When ordering, specify the handle finish as pewter colour or bronze.

**No reductions of any kind can be made on drawers, trays and pairs of side panels.**

### Warnings on using compartments adjacent to the corner element

It is impossible to use trouser or trinket trays (used individually).

### Wooden drawer finishes

melamine front in structure finish

fine grain finish front with pewter colour or bronze profile

drawer inside in grey saffiano melamine

### Glass drawer finishes

transparent glass front with pewter colour or bronze frame

inside in grey saffiano melamine

### Open drawer finishes

melamine front in structure finish

inside in grey saffiano melamine

# Molteni & C

### Items available

37—

41

#### Wooden drawers (melamine or fine grain)

##### STANDARD handle (pewter colour, bronze or Eco Skin finish)

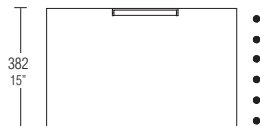
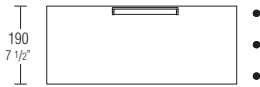

416 - 580 - 716 - 880 - 1208  
16 3/8 - 22 7/8 - 28 1/4 - 34 5/8 - 47 1/2

##### HOLD handle (pewter colour or bronze finish)



416 - 580 - 716 - 880 - 1208  
16 3/8 - 22 7/8 - 28 1/4 - 34 5/8 - 47 1/2

#### Glass drawers



416 - 580 - 716 - 880 - 1208  
16 3/8 - 22 7/8 - 28 1/4 - 34 5/8 - 47 1/2



416 - 580 - 716 - 880 - 1208  
16 3/8 - 22 7/8 - 28 1/4 - 34 5/8 - 47 1/2

#### Open drawers

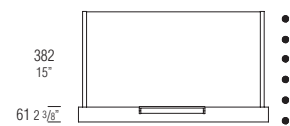

416 - 580 - 716 - 880 - 1208  
16 3/8 - 22 7/8 - 28 1/4 - 34 5/8 - 47 1/2

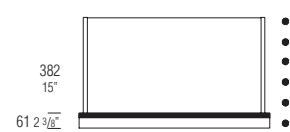

416 - 580 - 716 - 880 - 1208  
16 3/8 - 22 7/8 - 28 1/4 - 34 5/8 - 47 1/2

DATASHEET

REGISTERED  
DESIGN

IX.2018

## INTERNAL FITTINGS - MODULAR DRAWERS AND TRAYS

### Trouser holder finishes

melamine front in the same finish as the structure or fine grain with pewter colour or bronze profile  
 inner frame in grey saffiano melamine with trouser holder in grey saffiano embossed

### Trinket tray finishes

melamine front in the same finish as the structure or fine grain with pewter colour or bronze profile  
 inner frame, bottom and grid in grey saffiano melamine

### Pull-out trays finishes

melamine front in structure finish  
 with shelf and back in grey saffiano melamine

### STANDARD handle (pewter colour, bronze or Eco Skin finish)

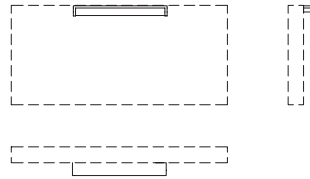

### HOLD handle (pewter colour or bronze finish)



### Notes

Prices of drawers, trays and pull-out trays include the cost of the pewter colour or bronze finish STANDARD handle. For the STANDARD handle covered in Eco Skin, add a supplementary charge for each.

Molteni & C

38—  
 41

### Trouser holder

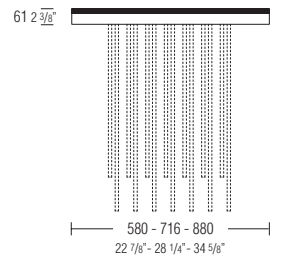
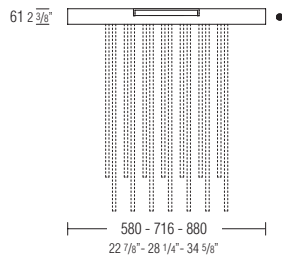

N.B.: usable only with suspended side panels as the bottom piece

### Trinket trays (tie and belt) with internal grid

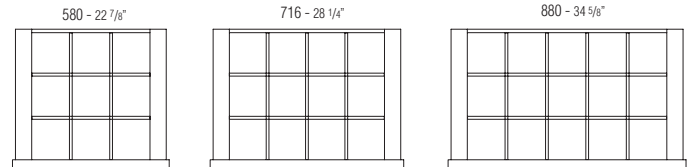
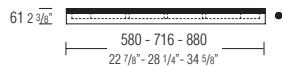
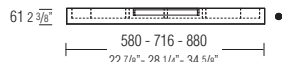

internal tray dividers

### Pull-out trays

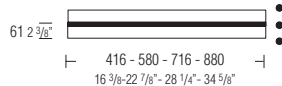
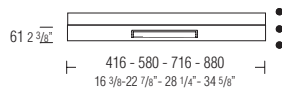

### DATASHEET

REGISTERED  
 DESIGN

IX.2018

## INTERNAL FITTINGS - ACCESSORIES FOR DRAWERS

### Leather trays

Handmade leather trays with Alcantara bottom.  
The version for men is brown (cat. P col. D533),  
The version for women is powder pink (cat. P col. D524).

### Eco Skin bottoms

Made with grey coloured Eco Skin.

Molteni & C

39 —  
41

### leather trays men's drawers

W 206 D 430 H 58 (A)  
W 206 D 215 H 58 (B)

watch holder  
(A)

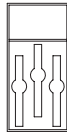

CEV/MA1

watch/  
bracelet holder  
(A)

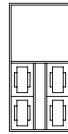

CEV/MA2

jewellery holder  
with movable dividers  
(B)



CEV/MB1

complete men's  
drawer offer

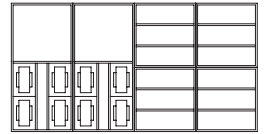

CVM1

### leather trays women's drawers

W 206 D 430 H 58 (A)  
W 206 D 215 H 58 (B)

watch holder  
(A)

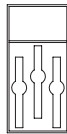

CEV/WA1

watch/  
bracelet holder  
(A)

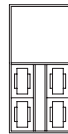

CEV/WA2

jewellery holder  
with movable dividers  
(B)



CEV/WB1

ring holder  
(B)



CEV/WB2

earring holder  
(B)



CEV/WB3

complete women's  
drawer offer

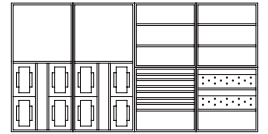

CVW1

### Modularity drawings for inserting trays into drawers

drawer W 416

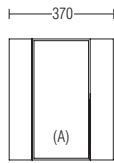

1 tray (A)  
or 2 trays (B)

drawer W 580

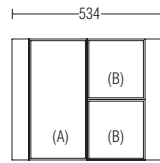

2 trays (A)  
or 4 trays (B)

drawer W 716

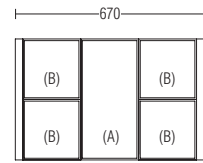

3 trays (A)  
or 6 trays (B)

drawer W 880

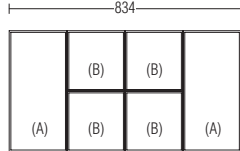

4 trays (A)  
or 8 trays (B)

drawer W 1208

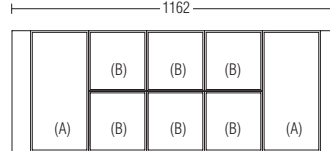

5 trays (A)  
or 10 trays (B)

### Eco Skin bottoms for drawers

D 432/473 special for 1st drawer with glass lid



W 366  
CEQ/F4

W 530  
CEQ/F6

W 666  
CEQ/F8

W 830  
CEQ/F9

W 1158  
CEQ/F13

### DATASHEET

REGISTERED  
DESIGN

IX.2018

## ISLAND DRAWER UNIT - DRAWER UNIT

### Island drawer unit

Made completely in larix dark or silver cembran melamine and available in two versions: with or without trinket trays in dolomite lacquer. Shelves in Eco Skin are available in colours in the catalogue. Standard handles are mounted, in pewter colour or bronze finish. It is possible to make STANDARD handles covered in Eco Skin with a supplemental charge for each.

#### version with trinket trays

- Side A has 6 drawers H 190 and 2 extractable trinket tray blocks.
- Side B has 4 drawers H 190 and and lower open compartments.

#### version without trinket trays

- Side A has 6 drawers H 190 and upper open compartment.
- Side B has 4 drawers H 190 and and lower open compartments.

**Dimensions of the island cannot be reduced, and the composition cannot be modified.**

It is possible to substitute the melamine drawers with glass drawers by adding the difference in price from **CLN8/19** and **CVN8/19**.

It is possible to substitute the melamine drawers with drawers with fine grain fronts by adding the difference in price of the finishes of the code **CLN8/19**.

Molteni & C

40 —  
 41

#### island drawer unit with trinket trays

W 1518 D 1022 H 897  
 W 59 3/4" D 40 1/4" H 35 3/8"

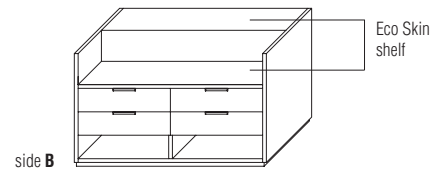
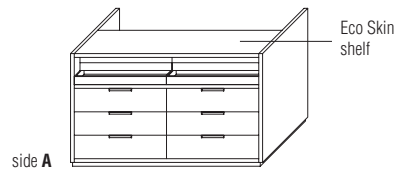

larix dark/silver cembran:  
 STANDARD handle  
 HOLD handle

**ISC15/09/1**

#### island drawer unit without trinket trays

W 1518 D 1022 H 897  
 W 59 3/4" D 40 1/4" H 35 3/8"

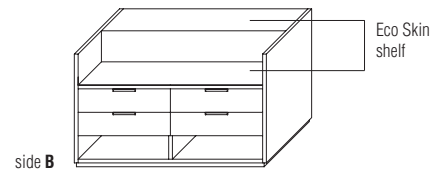
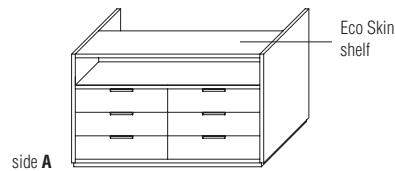

larix dark/silver cembran:  
 STANDARD handle  
 HOLD handle

**ISC15/09/2**

### Drawer unit

Made in larix dark, silver cembran or matt lacquer in Molteni range colours. Standard handles are mounted, in pewter colour finish. It is possible to make STANDARD handles covered in Eco Skin with a supplemental charge for each.

#### drawer unit

W 1292 D 527 H 897  
 W 50 7/8" D 20 3/4" H 35 3/8"

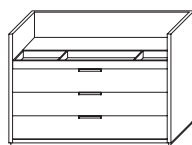

STANDARD handle    HOLD handle  
**ISC13/09/1**

### DATASHEET

REGISTERED  
 DESIGN

IX.2018

**ISLAND WITH TRANSPARENT GLASS DOORS**

Island that can be created with structure in transparent glass and horizontal parts in wood. Shelves are in wood except for those indicated (\*) which are always in glass.

The island cannot be reduced or modified with respect to the versions in the price list.

**Structure finish**  
 pewter colour  
 bronze

**Base unit / top / shelf finishes**  
 eucalyptus  
 graphite oak

**H 880 - 34 5/8"**  
 with top  
**D 1000 - 39 3/8"**

**W 1673 - 65 7/8"**

**W 2001 - 78 3/4"**

Molteni & C

41 —  
 41

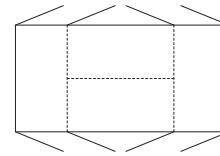
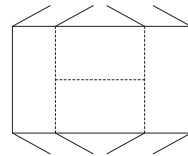
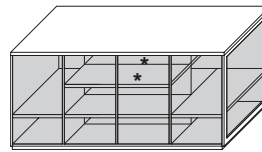
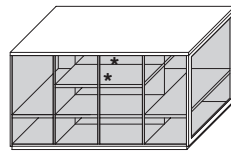

**ISV16/08**

**ISV20/08**

without LEDs  
 with LEDs

The island is available with or without LED lighting applied on all shelves and tops as shown. The system includes the cable holders and power supply units that enable it to work with a remote control.

**front**

**back**

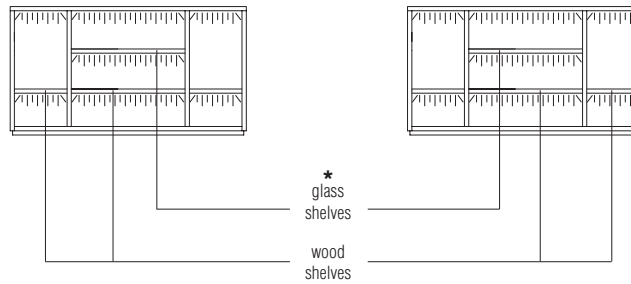

**DATASHEET**

REGISTERED  
 DESIGN

IX.2018

## FINISHES MOLTENI&C RANGE

IX.2018

	MATT LACQUER	GLOSSY LACQUER	COLOURED GLASS	ETCHED COLOURED GLASS	CARTAPAGLIA LACQUERED <i>only Gliss Master</i>	STOPSOL GLASS TRANSPARENT STOPSOL GLASS
CHALK WHITE	•	•	•	•	•	
PEARL	•	•	•	•	•	
SILICA	•	•	•	•	•	
SAND	•	•	•	•	•	
DOVE GREY	•	•	•	•	•	
PLATINUM	•	•	•	•	•	
DUNE	•	•	•	•	•	
CLAY	•	•	•	•	•	
DOLOMITE GREY	•	•	•	•	•	
COPPER	•	•	•	•	•	
RUST	•	•	•	•	•	
RUBY	•	•	•	•	•	
CARAMEL	•	•	•	•	•	
MOKA	•	•	•	•	•	
MUSTARD	•	•	•	•	•	
LIGHT BLUE GREY	•	•	•	•	•	
PEWTER COLOUR	•	•	•	•	•	
ANTHRACITE	•	•	•	•	•	
BLACK	•	•	•	•	•	
STOPSOL						•
LESSLESS RED	•					
		only matt lacquer				

# Molteni & C

## FINISHES MOLTENI&C RANGE

IX.2018

### WOODS

EUCALYPTUS

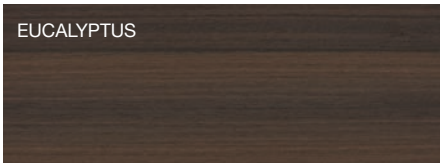

AMERICAN WALNUT

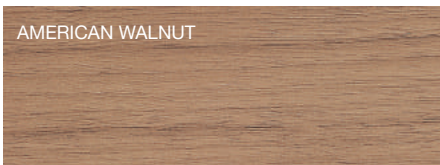

GRAPHITE OAK

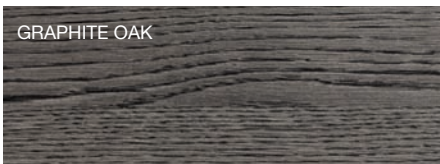

GREY OAK

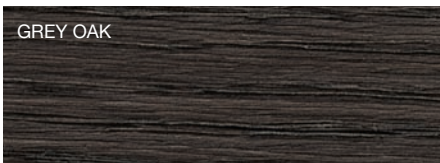

BLACK OAK

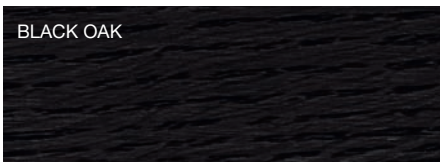

WALNUT

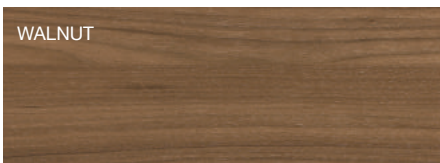

CEDAR



ASH WOOD IN NATURAL COLOUR



ASH WOOD STAINED BLACK

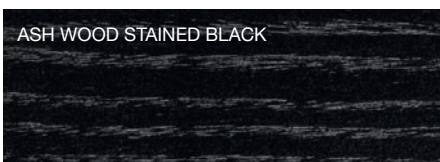

### MARBLES

WHITE CARRARA

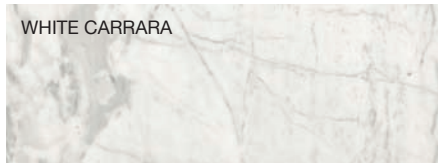

RED LAGUNA

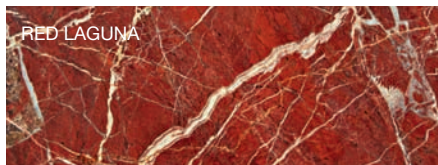

EMPERADOR DARK

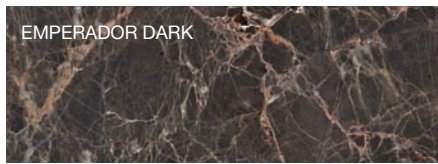

BLACK MARQUINA

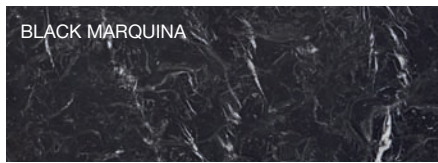

ORIENT GREY

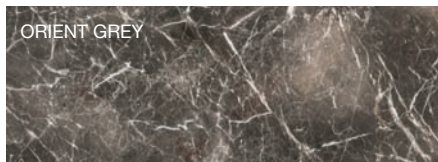

SAHARA NOIR

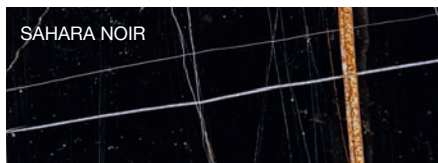

CALACATTA GOLD



### METAL PARTS

BLACK CHROME

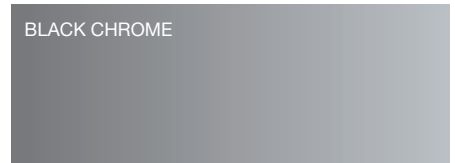

SHINY ALUMINIUM

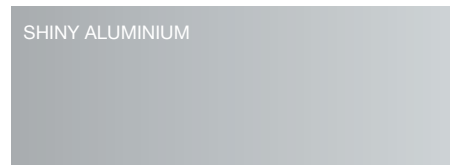

PEWTER COLOUR

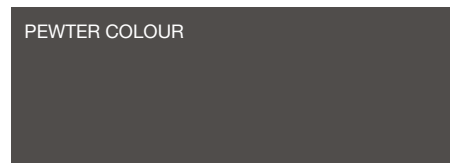

COPPER

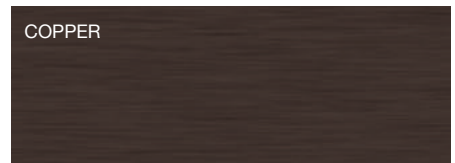

BRONZE



DWELL  
DOOR FRAME, TRACK COVERING PROFILES

ANODISED ALUMINIUM



BROWN ALUMINIUM

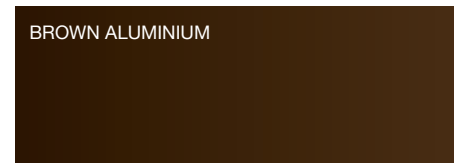

The finishes shown are indicative and refer to the entire production range. We recommend that you consult the "Colour Range" samples which shown the complete range of finishes, including those not shown here. Molteni&C reserves the right to modify the range without warning.

# Molteni & C

## FINISHES MOLTENI&C RANGE

IX.2018

MELAMINE FRONT  
GLISS MASTER

CARTAPAGLIA WHITE



CARTAPAGLIA ANTHRACITE

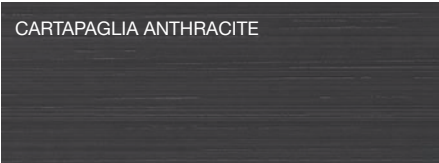

CARTAPAGLIA SILICA



GRAFFIATO SILICA



GRAFFIATO BRONZE

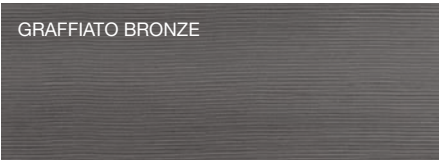

SILK DOVE GREY



SILK SILICA



SILK CHALK WHITE



MELAMINE STRUCTURE  
GLISS MASTER

WHITE SHANTUNG

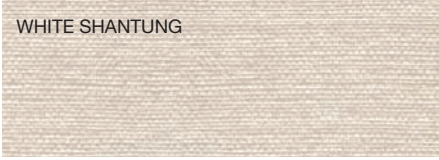

GREY SHANTUNG



MELAMINE STRUCTURE  
GLISS MASTER, MASTER DRESSING,  
GLISS WALK-IN

SILVER CEMBRAN

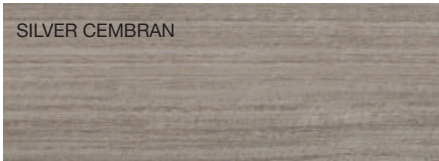

LARIX DARK

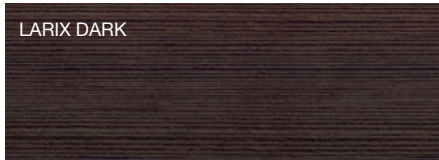

MELAMINE STRUCTURE  
GLISS MASTER, MASTER DRESSING

WHITE



ECO SKIN

IVORY



HEMP



MINK



DARK BROWN



GREY



FINE GRAIN

FINE GRAIN

